



# 7400

(Gas/LPG)

(007000- )

(GM Engine)

**Rider Scrubber  
Operator Manual**

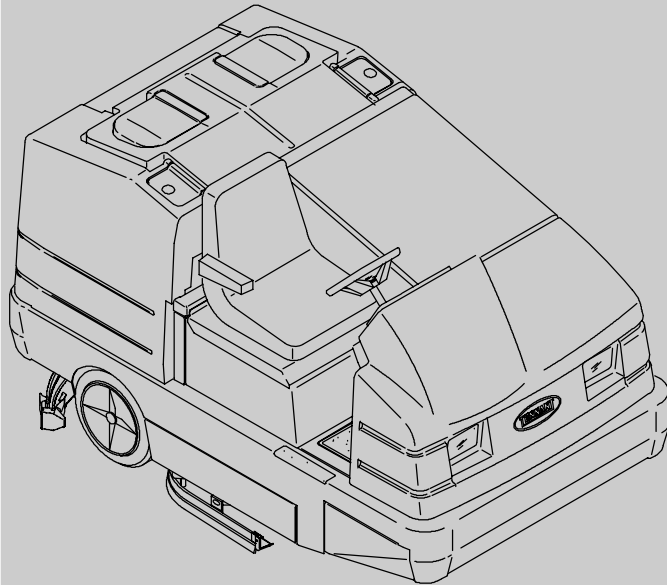

***The Safe Scrubbing Alternative®***

***ES® Extended Scrub System***

**North America / International**

[www.tennantco.com](http://www.tennantco.com)

**330970**

Rev. 04 (3-2007)





This manual is furnished with each new model. It provides necessary operation and maintenance instructions.

**Read this manual completely and understand the machine before operating or servicing it.**

This machine will provide excellent service. However, the best results will be obtained at minimum costs if:

- The machine is operated with reasonable care.
- The machine is maintained regularly - per the machine maintenance instructions provided.
- The machine is maintained with manufacturer supplied or equivalent parts.

	<b>PROTECT THE ENVIRONMENT</b> Please dispose of packaging materials, old machine components such as batteries, hazardous fluids such as antifreeze and oil, in an environmentally safe way according to local waste disposal regulations.   Always remember to recycle.
---	---

<b>MACHINE DATA</b>	
Please fill out at time of installation for future reference.	
Model No. -	_____
Serial No. -	_____
Machine Options -	_____
Sales Rep. -	_____
Sales Rep. phone no. -	_____
Customer Number -	_____
Installation Date -	_____

**Tennant Company**  
PO Box 1452  
Minneapolis, MN 55440  
Phone: (800) 553-8033 or (763) 513-2850  
www.tennantco.com

 **CALIFORNIA PROPOSITION 65 WARNING:**  
**Engine exhaust from this product contains chemicals known to the State of California to cause cancer, birth defects, or other reproductive harm.**

FaST-PAK is a US registered and unregistered trademark of Tennant Company.

Specifications and parts are subject to change without notice.

Copyright © 1998-2000, 2002-2007 TENNANT Company, Printed in U.S.A.

**CONTENTS**

	Page		Page
SAFETY PRECAUTIONS .....	3	POST-OPERATION CHECKLIST .....	45
OPERATION .....	7	OPERATION ON INCLINES .....	45
OPERATOR RESPONSIBILITY .....	7	OPTIONS .....	46
MACHINE COMPONENTS .....	8	VACUUM WAND .....	46
SYMBOL DEFINITIONS .....	9	MACHINE TROUBLESHOOTING .....	49
CONTROLS AND INSTRUMENTS .....	10	MAINTENANCE .....	52
OPERATION OF CONTROLS .....	11	MAINTENANCE CHART .....	52
DIRECTIONAL PEDAL .....	11	LUBRICATION .....	54
BRAKE PEDAL .....	12	ENGINE .....	54
PARKING BRAKE PEDAL .....	12	REAR WHEEL BEARINGS .....	54
CHARGING SYSTEM LIGHT .....	12	FRONT WHEEL SUPPORT BEARING .....	54
ENGINE OIL PRESSURE LIGHT .....	13	SCRUB BRUSH IDLER .....	55
HIGH ENGINE TEMPERATURE		HYDRAULICS .....	55
LIGHT .....	13	HYDRAULIC FLUID RESERVOIR .....	55
MAINTENANCE MODE LIGHT .....	13	HYDRAULIC FLUID .....	56
RECOVERY TANK FULL LIGHT .....	14	HYDRAULIC HOSES .....	56
FUEL LEVEL LOW LIGHT .....	14	ENGINE .....	57
OK LIGHT .....	14	COOLING SYSTEM .....	57
FUEL LEVEL GAUGE .....	15	AIR FILTER INDICATOR .....	59
HOURMETER .....	15	AIR FILTER .....	60
SQUEEGEE SWITCH .....	15	SPARK PLUGS .....	60
ES SWITCH (OPTION) .....	16	CRANKCASE VENTILATION SYSTEM .....	60
SIDE BRUSH SWITCH (OPTION) .....	16	TIMING BELT .....	60
DETERGENT FLOW SWITCH		FUEL FILTER (GASOLINE) .....	60
(OPTION) .....	16	FUEL FILTER (LPG) .....	61
SCRUB SWITCH .....	17	ELECTRONIC PRESSURE REGULATOR	
ENGINE SPEED SWITCH .....	18	(LPG) (For machines serial number	
STEERING WHEEL .....	18	009000 and above) .....	61
COVER RELEASE KNOB .....	18	ELECTRONIC FUEL INJECTION .....	61
HORN BUTTON .....	19	BATTERY .....	62
IGNITION SWITCH .....	19	PROPELLING MOTOR .....	62
STEERING COLUMN TILT HANDLE .....	19	BELTS AND CHAINS .....	62
CHECK ENGINE LIGHT .....	20	ENGINE BELT .....	62
CIRCUIT BREAKERS .....	20	STATIC DRAG CHAIN .....	62
FUSES .....	21	SCRUB BRUSHES .....	63
SOLUTION FLOW SWITCH		REPLACING OR ROTATING THE	
(WITHOUT FaST) .....	22	SCRUB BRUSHES .....	64
SOLUTION FLOW SWITCH (FaST) .....	22	CHECKING AND ADJUSTING	
FaST SWITCH .....	22	SCRUB BRUSH PATTERN .....	65
SOLUTION TANK DRAIN HOSE .....	23	SOLUTION SYSTEM .....	68
RECOVERY TANK DRAIN HOSE .....	23	RECOVERY TANK .....	68
OPERATOR SEAT .....	24	SOLUTION TANK .....	68
LATCHES .....	24	DEBRIS TRAY .....	68
HOW THE MACHINE WORKS .....	25	FaST SYSTEM .....	69
FaST SCRUBBING SYSTEM .....	26	FaST SUPPLY HOSE CONNECTOR .....	69
PRE-OPERATION CHECKLIST .....	27	FaST SYSTEM FILTER SCREEN .....	69
INSTALLING FaST PAK AGENT .....	28	FaST SYSTEM AIR PUMP FILTER .....	69
CHANGING AN LPG FUEL TANK .....	30	FaST SPRAY TUBE .....	70
STARTING THE MACHINE .....	31	SQUEEGEES .....	70
SCRUBBING AND BRUSH INFORMATION .....	33	ADJUSTING REAR SQUEEGEE	
FILLING THE TANKS .....	34	BLADE DEFLECTION .....	70
SCRUBBING .....	36	LEVELING THE REAR SQUEEGEE .....	72
DOUBLE SCRUBBING .....	39		
STOP SCRUBBING .....	39		
DRAINING AND CLEANING THE TANKS .....	40		
STOP THE MACHINE .....	43		

# CONTENTS

---

	Page
SQUEEGEE BLADES .....	73
REAR SQUEEGEE .....	73
REPLACING OR ROTATING REAR SQUEEGEE BLADES .....	73
SIDE SQUEEGEES .....	74
REPLACING SIDE SQUEEGEE BLADES .....	74
SKIRTS AND SEALS .....	75
SCRUB HEAD SKIRTS .....	75
COVER SEALS .....	75
BRAKES AND TIRES .....	76
SERVICE BRAKES .....	76
PARKING BRAKE .....	76
TIRES .....	76
FRONT WHEEL .....	76
PUSHING, TOWING, AND TRANSPORTING THE MACHINE ....	77
PUSHING OR TOWING THE MACHINE	77
TRANSPORTING THE MACHINE ....	78
MACHINE JACKING .....	80
STORING MACHINE .....	80
OPTIONS .	81
SIDE BRUSH .....	81
REPLACING THE SIDE SCRUB BRUSH .....	81
REPLACING THE SQUEEGEE BLADE .....	82
SIDE BRUSH SKIRT .....	82
SPECIFICATIONS .....	83
GENERAL MACHINE PERFORMANCE ..	83
FaST SYSTEM .....	83
POWER TYPE .....	84
STEERING .....	84
HYDRAULIC SYSTEM .....	84
MACHINE DIMENSIONS .....	85
INDEX .....	86

## SAFETY PRECAUTIONS

The following precautions are used throughout this manual as indicated in their description:



**WARNING:** To warn of hazards or unsafe practices that could result in severe personal injury or death.



**CAUTION:** To warn of unsafe practices that could result in minor or moderate personal injury.

**FOR SAFETY:** To identify actions that must be followed for safe operation of equipment.

The machine is suited to sweep disposable debris. Do not use the machine other than described in this Operator Manual. The machine is not designed for use on public roads.

The following information signals potentially dangerous conditions to the operator or equipment:



**WARNING:** Flammable materials can cause an explosion or fire. Do not use flammable materials in tank(s).



**WARNING:** Flammable materials or reactive metals can cause an explosion or fire. Do not pickup.



**WARNING:** Moving belt and fan. Keep away.



**WARNING:** Strong Vacuum. Keep Away From Fan Inlet When Fan Is Running.



**WARNING:** Engine emits toxic gases. Severe respiratory damage or asphyxiation can result. Provide adequate ventilation. Consult with your regulatory authorities for exposure limits. Keep engine properly tuned.



**WARNING:** Hot bumper. Keep away.



**CAUTION:** LPG engine will run for a few seconds after key is turned off. Apply parking brake before leaving machine.

## FOR SAFETY:

1. Do not operate machine:
  - Unless trained and authorized.
  - Unless operator manual is read and understood.
  - If it is not in proper operating condition.
  - In flammable or explosive areas unless designed for use in those areas.
  - In areas with possible falling objects unless equipped with overhead guard.
2. Before starting machine:
  - Check for fuel, oil, and liquid leaks.
  - Keep sparks and open flame away from refueling area.
  - Make sure all safety devices are in place and operate properly.
  - Check brakes and steering for proper operation.
3. When starting machine:
  - Keep foot on brake and directional pedal in neutral.
4. When using machine:
  - Use brakes to stop machine.
  - Go slow on inclines and slippery surfaces.
  - Use care when reversing machine.
  - Do not carry passengers on machine.
  - Always follow safety and traffic rules.
  - Report machine damage or faulty operation immediately.
  - Follow mixing and handling instructions on chemical containers.
5. Before leaving or servicing machine:
  - Stop on level surface.
  - Set parking brake.
  - Turn off machine and remove key.

## **SAFETY PRECAUTIONS**

---

- 6. When servicing machine:**
  - **Avoid moving parts. Do not wear loose jackets, shirts, or sleeves.**
  - **Block machine tires before jacking machine up.**
  - **Jack machine up at designated locations only. Block machine up with jack stands.**
  - **Use hoist or jack that will support the weight of the machine.**
  - **Wear eye and ear protection when using pressurized air or water.**
  - **Disconnect battery connections before working on machine.**
  - **Avoid contact with battery acid.**
  - **Avoid contact with hot engine coolant.**
  - **Allow engine to cool.**
  - **Keep flames and sparks away from fuel system service area. Keep area well ventilated.**
  - **Use cardboard to locate leaking hydraulic fluid under pressure.**
  - **Use Tennant supplied or approved replacement parts.**
  
- 7. When loading/unloading machine onto/off truck or trailer:**
  - **Turn off machine.**
  - **Use truck or trailer that will support the weight of the machine.**
  - **Use winch. Do not drive the machine onto/off the truck or trailer unless the load height is 380 mm (15 in) or less from the ground.**
  - **Set parking brake after machine is loaded.**
  - **Block machine tires.**
  - **Tie machine down to truck or trailer.**

The following safety labels are mounted on the machine in the locations indicated. If these or any labels become damaged or illegible, install a new label in its place.

**FOR SAFETY LABEL - LOCATED ON THE SIDE OF THE OPERATOR COMPARTMENT.**

**EMISSIONS LABEL - LOCATED ON THE SIDE OF THE OPERATOR COMPARTMENT.**



**LPG ENGINE WILL RUN LABEL - LOCATED NEXT TO THE IGNITION SWITCH ON THE INSTRUMENT PANEL.**

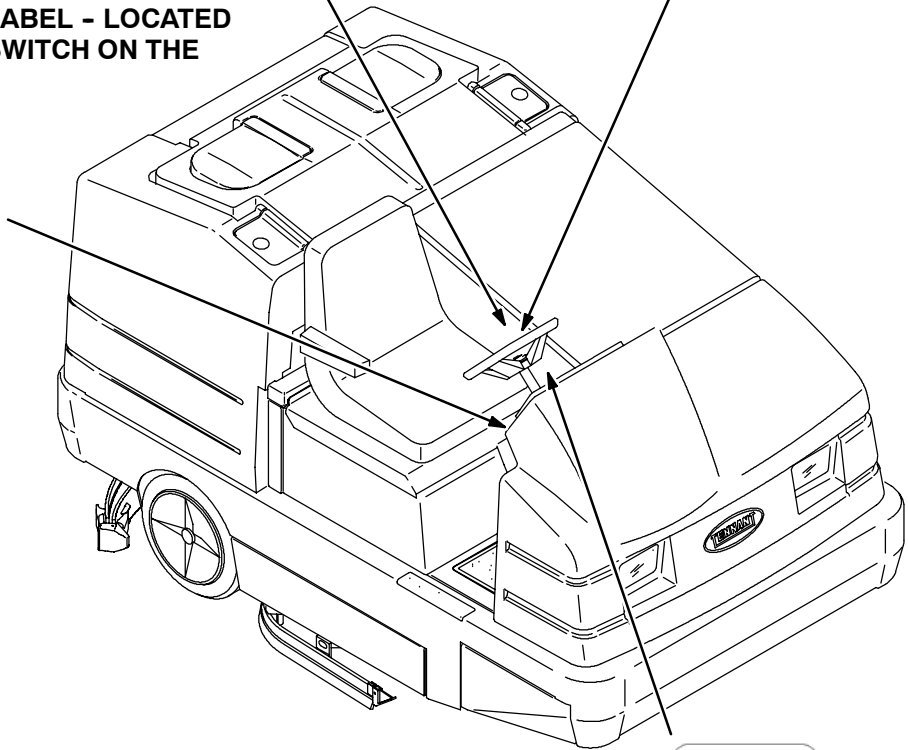
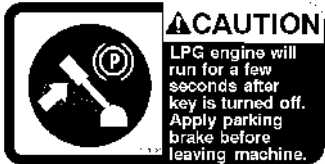

10783

**FLAMMABLE SPILLS LABEL - LOCATED ON THE SIDE OF THE OPERATOR COMPARTMENT.**

# SAFETY PRECAUTIONS

FAN AND BELT LABEL - LOCATED ON THE ENGINE COMPARTMENT LINTEL.



STRONG VACUUM LABEL - LOCATED ON THE VACUUM FAN HOUSING.



HOT SURFACE LABEL - LOCATED ON THE SIDE OF THE BUMPER.

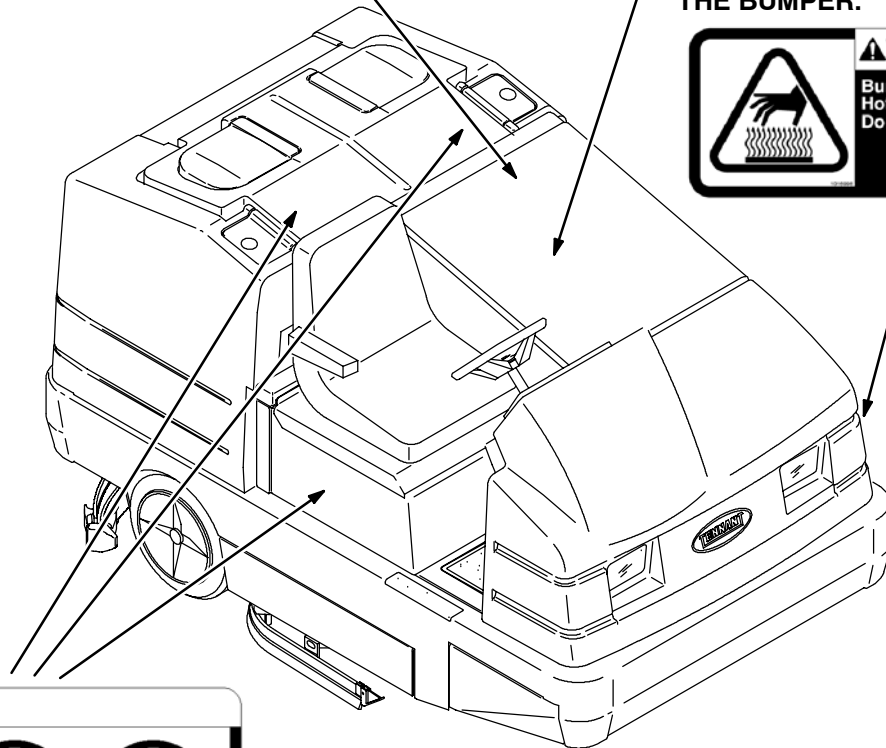

FLAMMABLE MATERIALS LABEL - LOCATED NEXT TO THE SOLUTION TANK COVERS AND ON THE DETERGENT TANK.

10783



## OPERATION

---

**OPERATOR RESPONSIBILITY**

---

- The operator's responsibility is to take care of the daily maintenance and checkups of the machine, to keep it in good working condition. The operator must inform the service mechanic or supervisor when the required maintenance intervals occur as stated in the *MAINTENANCE* section of this manual.
- Read this manual carefully before operating this machine.

**FOR SAFETY: Do not operate machine, unless operation manual is read and understood.**

- Check the machine for shipping damage. Check to make sure the machine is complete per shipping instructions.
- Keep your machine regularly maintained by following the maintenance information in this manual. We recommend taking advantage of a regularly scheduled service contract from your Tennant representative.
- Order parts and supplies directly from your authorized Tennant representative. Use the parts manual provided when ordering parts.
- After the first 50 hours of operation, follow the recommended procedures stated in the *MAINTENANCE CHART*.

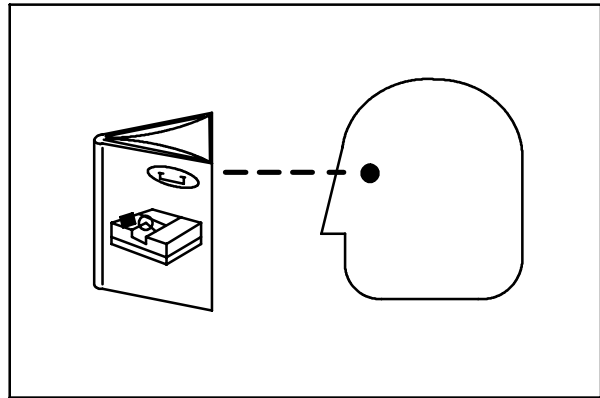

07324

# OPERATION

## MACHINE COMPONENTS

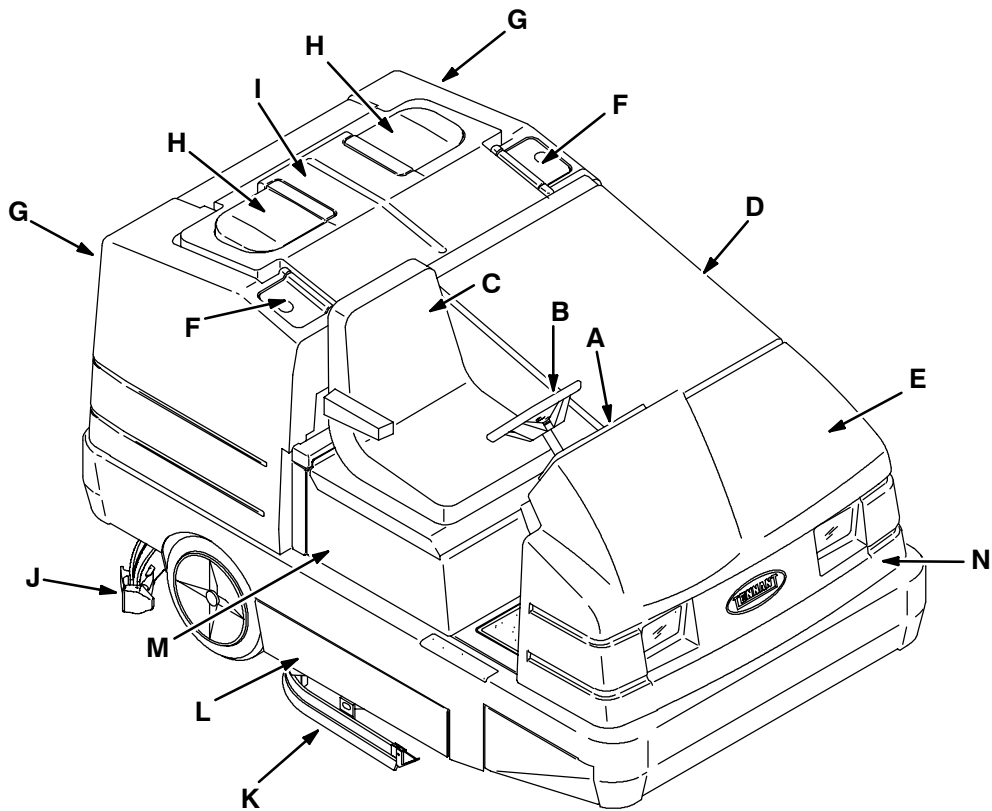

10783

- A. Instrument panel
- B. Steering wheel
- C. Operator seat
- D. Engine cover
- E. Machine front cover
- F. Solution tank covers
- G. Solution tanks
- H. Recovery tank covers
- I. Recovery Tank
- J. Rear squeegee
- K. Side Squeegee
- L. Scrub brush access door
- M. FaST solution system
- N. Fuel tank

**SYMBOL DEFINITIONS**

These symbols identify controls, displays, and features on the machine:

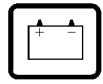

Charging system



Engine oil pressure



High engine temperature



Maintenance mode



Recovery tank full



Fuel



Diagnostics



Hourmeter



ES



Side brush down and on



Rear squeegee down and vacuum on

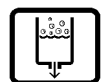

Detergent flow

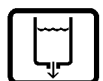

Solution flow



Scrub brushes down and on



Engine



Steering tilt



Horn



Ignition switch



Circuit breaker 1



Circuit breaker 2



Circuit breaker 3



Circuit breaker 4



Circuit breaker 5



Circuit breaker 7



Circuit breaker 8



Cover release



Hydraulic fluid only



Gasoline fuel only



Jack-point



Check Engine

# OPERATION

## CONTROLS AND INSTRUMENTS

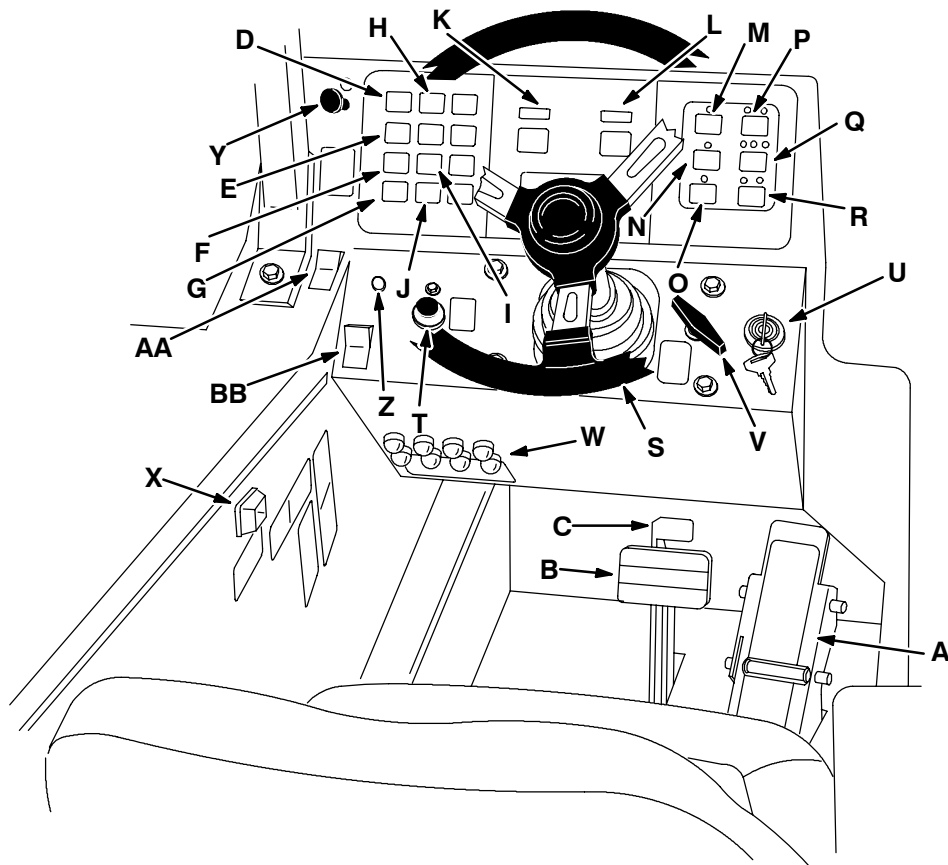

- A. Directional pedal
- B. Brake pedal
- C. Parking brake pedal
- D. Charging system light
- E. Engine oil pressure light
- F. High engine temperature light
- G. Maintenance mode light
- H. Recovery tank full light
- I. Fuel level low light
- J. OK light
- K. Fuel level gauge
- L. Hourmeter
- M. ES switch (option)
- N. Side brush switch (option)
- O. Squeegee switch
- P. Detergent flow switch (option)
- Q. Scrub switch
- R. Engine speed switch
- S. Steering wheel
- T. Horn button
- U. Ignition switch
- V. Steering column tilt lever
- W. Circuit breakers
- X. Solution flow switch
- Y. Cover release knob
- Z. Check engine light
- AA. FaST switch
- BB. FaST solution flow switch

10654

---

**OPERATION OF CONTROLS**

---

**DIRECTIONAL PEDAL**

The directional pedal controls direction of travel and the propelling speed of the machine. You change the speed of the machine with the pressure of your foot; the harder you press the faster the machine travels.

**Forward:** Press the top of the directional pedal with the toe of your foot.

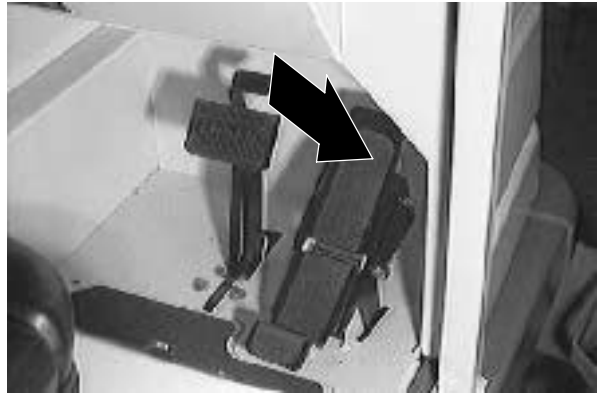

**Reverse:** Press the bottom of the directional pedal with the heel of your foot.

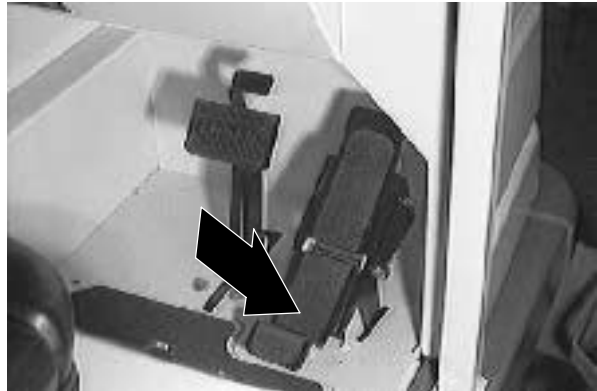

**Neutral:** Take your foot off the directional pedal and it will return to the neutral position.



## OPERATION

### BRAKE PEDAL

The brake pedal stops the machine.

Stop: Take your foot off the directional pedal and let it return to the neutral position. Step on the brake pedal.



### PARKING BRAKE PEDAL

The parking brake pedal sets and releases the rear wheel brakes.

Set: Press on the brake pedal as far as possible, then press on the parking brake pedal with the toe portion of your foot to lock the parking brake pedal in place.

**FOR SAFETY: Before leaving or servicing machine; stop on level surface, set parking brake, turn off machine and remove key.**

Release: Press on the brake pedal to unlock the parking brake pedal.



### CHARGING SYSTEM LIGHT

The charging system light comes on when the alternator is not operating within normal range; 13.5 to 14.5 Volts. Stop operating the machine. Locate the problem and have it corrected.

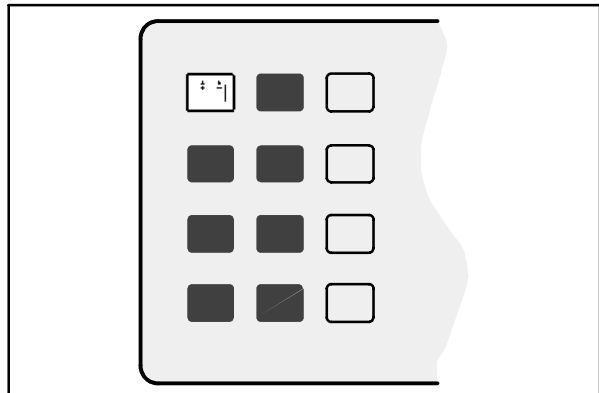

10642

**ENGINE OIL PRESSURE LIGHT**

The engine oil pressure light comes on when the engine oil pressure falls below 40 kPa (5 psi). Stop operating the machine. Locate the problem and have it corrected.

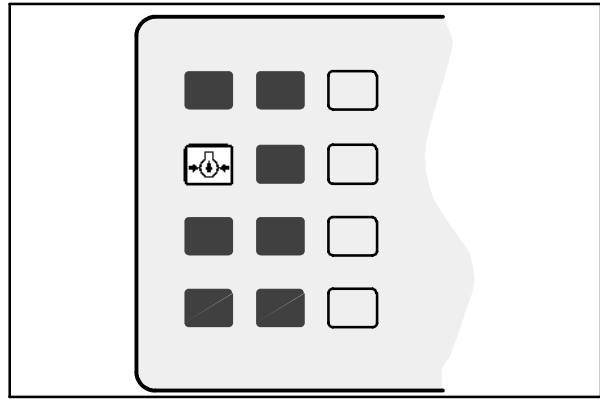

10643

**HIGH ENGINE TEMPERATURE LIGHT**

The high engine temperature light comes on when the temperature of the engine coolant is more than 107° C (225° F). If the light comes on, stop operating the machine. Locate the problem and have it corrected.

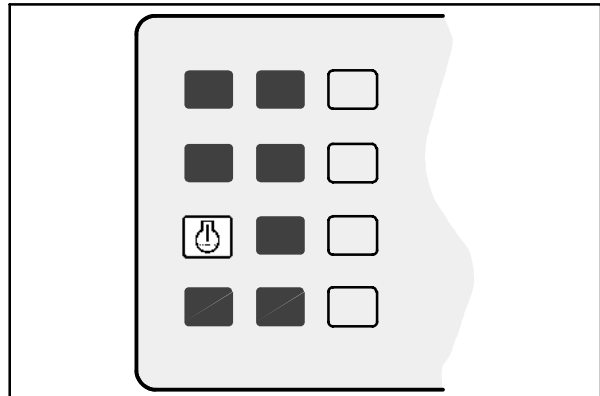

10644

**MAINTENANCE MODE LIGHT**

The maintenance mode light comes on when the control panel diagnostic mode is manually activated. The maintenance mode is for service personnel use only. To clear the diagnostic mode, turn the ignition key all the way counter-clockwise.

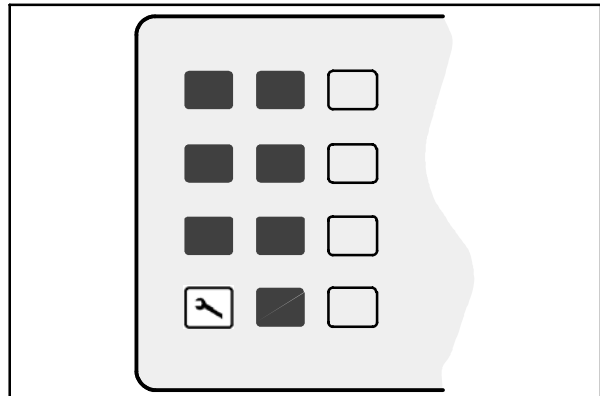

10645

## OPERATION

### RECOVERY TANK FULL LIGHT

The recovery tank full light starts blinking when the recovery tank is full. The light will blink for one minute and then stay on. Then the scrubbing operations will shut off.

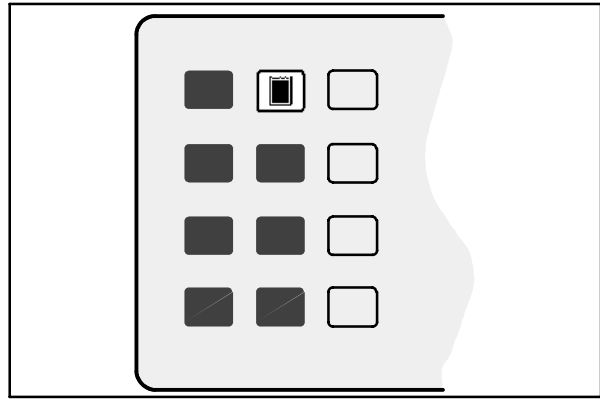

10886

### FUEL LEVEL LOW LIGHT

The fuel level low light comes on when the gasoline or LPG fuel tank is almost empty. The LPG fuel tank has five minutes of fuel remaining when the level light comes on.

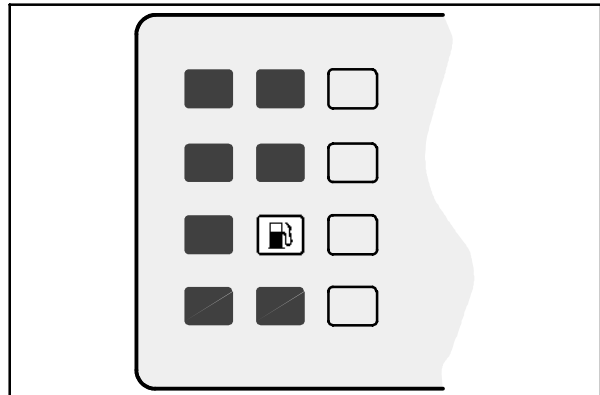

10888

### OK LIGHT

The OK light comes on after the control panel has run through and passed a self-check every time the machine is started. The OK light will go out when the scrub or squeegee switch is activated, or the engine speed is changed to (Fast).

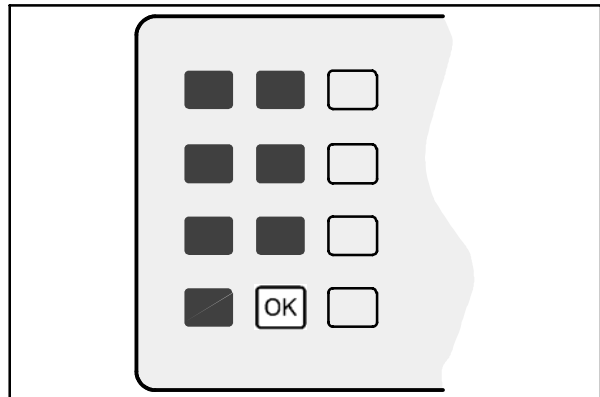

10889

### HOURMETER

The hourmeter records the number of hours the machine has been operated. The hourmeter displays the number of hours in tenths of an hour. Use this information to determine machine maintenance intervals.

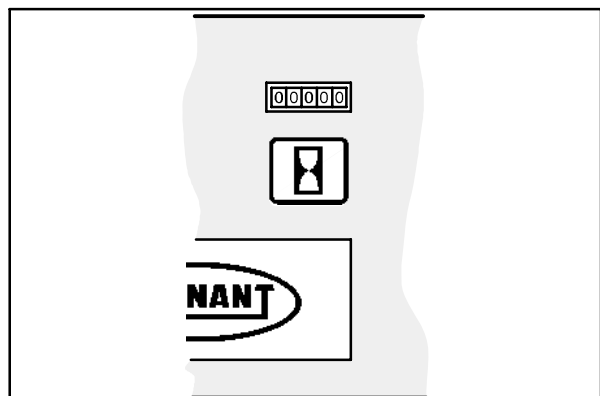

07765



## FUEL LEVEL GAUGE

The fuel level gauge indicates how much fuel is in the fuel tank with a segmented LED light.

Gasoline powered machine: When the tank is full, all ten of the LED segments are lit. As the fuel tank empties, the LED segments shut off. The fuel tank is empty when all ten of the LED segments have shut off. The fuel level low light comes on when the last three LED segments are lit.

LPG powered machines: The fuel level gauge is not operational on LPG machines. However, the fuel level low light comes on when there is five minutes of fuel remaining in the tank.

**NOTE:** Do not use leaded fuels. The use of leaded fuels will cause permanent damage to the system's oxygen sensor and the catalytic converter.

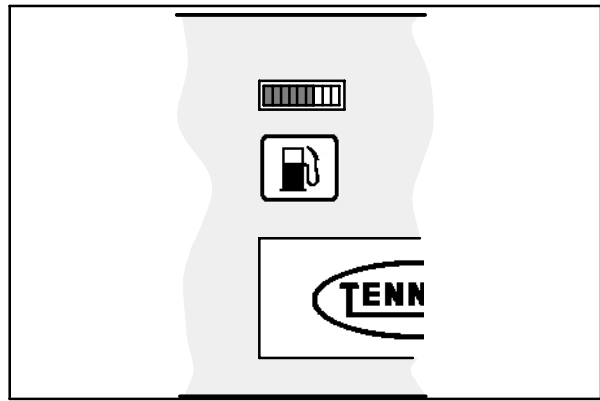

07764

## SQUEEGEE SWITCH

The squeegee switch controls the position of the rear squeegee, and starts and stops the vacuum fan. The rear squeegee can be operated separately, from the scrub brushes, for water pick-up.

Lower and start: Press the squeegee switch. The indicator light above the switch will come on.

Raise and stop: Press the squeegee switch. The indicator light above the switch goes off. There will be a slight delay before the vacuum fan shuts off.

**NOTE:** The rear squeegee lowers and the vacuum fan starts automatically when the scrubbing operations start.

**NOTE:** The rear squeegee will raise and the vacuum fan will stop when the machine travels in reverse.

**NOTE:** The rear squeegee will raise and the vacuum fan will shut off after a short delay when the scrubbing operations are shut off.

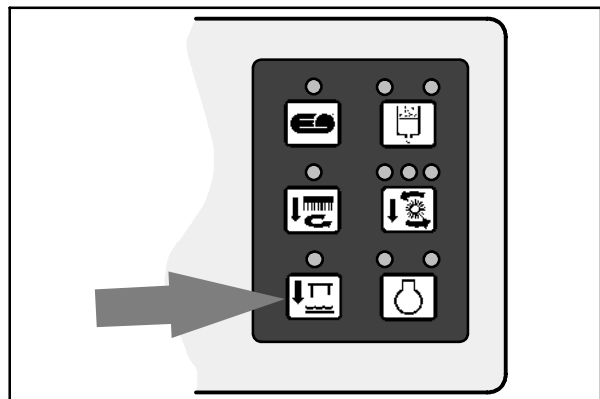

10892

## OPERATION

### ES SWITCH (OPTION)

The ES switch turns on and off the extended scrub system. When the machine is started, the ES switch will default to the last setting used.

**On:** Press the ES switch. The indicator light above the switch will come on.

**Off:** Press the ES switch. The indicator light above the switch goes off.

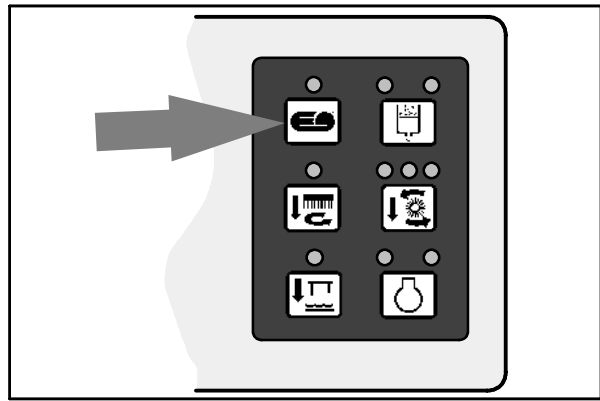

10890

### SIDE BRUSH SWITCH (OPTION)

The side brush switch controls the position and rotation of the side brush, and the solution flow to the side brush. When the machine is started, the side brush switch will default to the last setting used.

**Down and on:** Press the side brush switch. The indicator above the switch comes on.

**Up and off:** Press the side brush switch. The indicator above the switch goes off.

*NOTE: The side brush will lower and start when the scrubbing operations start. The main scrub brushes have to be on for the side brush to operate.*

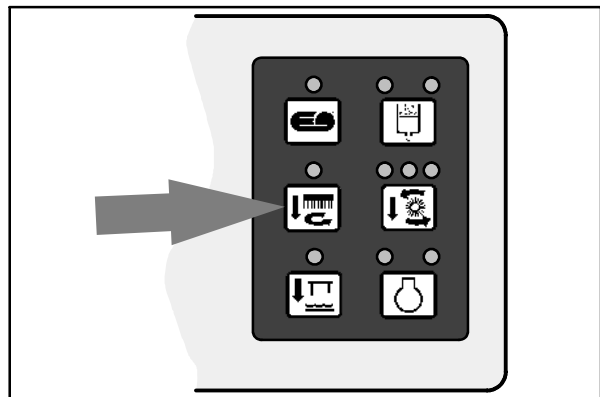

10891

### DETERGENT FLOW SWITCH (OPTION)

The detergent flow switch starts and stops the detergent pump for the optional ES system. When the machine is started, the detergent flow switch will default to the last setting used.

**Start at one-half flow:** Press the detergent flow switch. The left indicator light above the switch will come on.

**Increase to full flow:** Press and hold the detergent flow switch until both indicator lights above the switch come on.

**Stop:** Press the detergent flow switch. Both indicator lights are off.

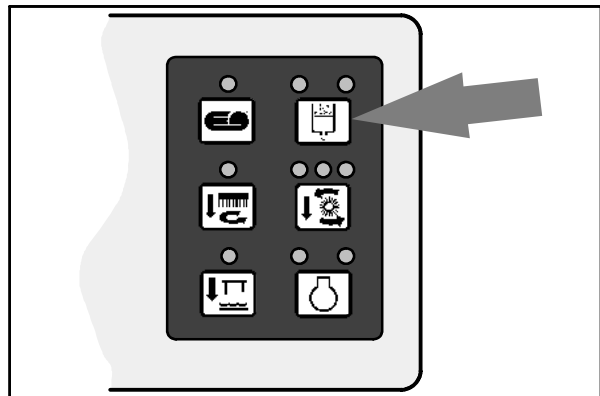

10893

## SCRUB SWITCH

The scrub switch controls the scrubbing operations. The scrub switch also sets the scrub brush pressure.

The scrubbing operations include the following. The scrub head lowers and the brushes turn on. The rear squeegee will lower and the vacuum fan will start. The solution system will start, if the solution flow switch is on. The FaST system or optional ES system and detergent pump will start, if the switches are on. The optional side brush will lower and turn on, if the side brush switch is on. The engine speed will change to (Fast).

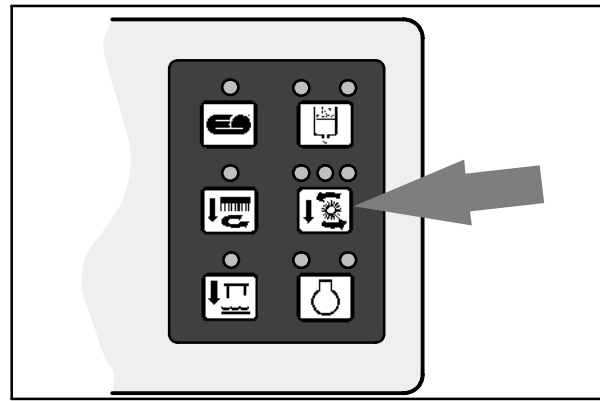

10894

*NOTE: The brush pressure setting, the FaST system, the detergent flow rate, the side brush, and the ES system will default to the last setting used when the scrubbing operations are started again.*

**Start:** Press the scrub switch. The indicator light above the switch will come on.

**Stop:** Press the scrub switch. The indicator light above the switch goes off.

**Scrub brush pressure:** Press and hold the scrub switch. The brush pressure will scroll through the three settings. The pressure setting selected when the switch is released, will be the new default brush pressure setting.

The brush pressure has three positions. Under normal conditions, the brush pressure should be set in the minimum setting. Under heavy grime conditions, the brush pressure should be set in the maximum setting. Travel speed and floor conditions will affect the scrubbing performance.

*NOTE: The scrub head and squeegee will raise when the machine travels in reverse.*

## OPERATION

### ENGINE SPEED SWITCH

The engine speed switch controls the engine governed speed. The two indicator lights above the switch show the engine speed; idle or fast.

**Idle:** The engine will automatically start in idle speed. To return the engine to idle from the (Fast) engine speed, press the engine speed switch until the left indicator light comes on. The scrubbing operations will turn off automatically.

**Fast:** Press the engine speed switch and the right indicator light comes on. This speed is for transporting and scrubbing.

*NOTE: The engine will automatically operate in the (Fast) speed when the scrubbing operations are started.*

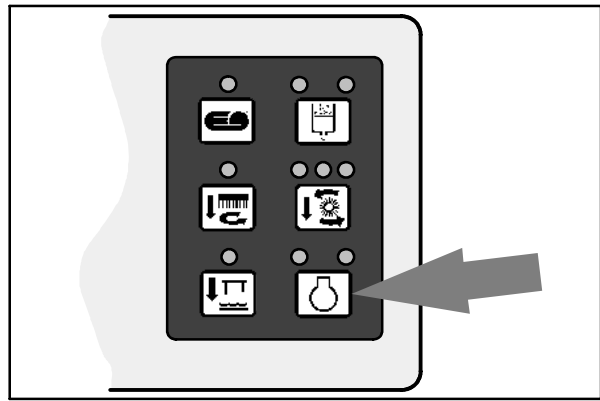

10895

### STEERING WHEEL

The steering wheel controls the machine's direction. The machine is very responsive to the steering wheel movements.

**Left:** Turn the steering wheel to the left.

**Right:** Turn the steering wheel to the right.

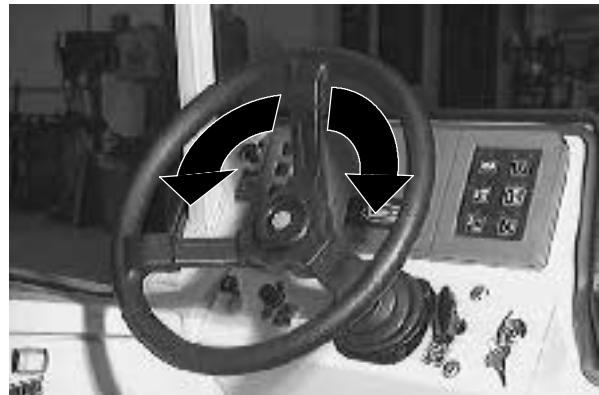

### COVER RELEASE KNOB

The cover release knob releases the machine front cover latch.

**To release:** Pull out and hold the cover release knob, then pull open the machine cover.



## HORN BUTTON

The horn button operates the horn.

Sound: Press the button.

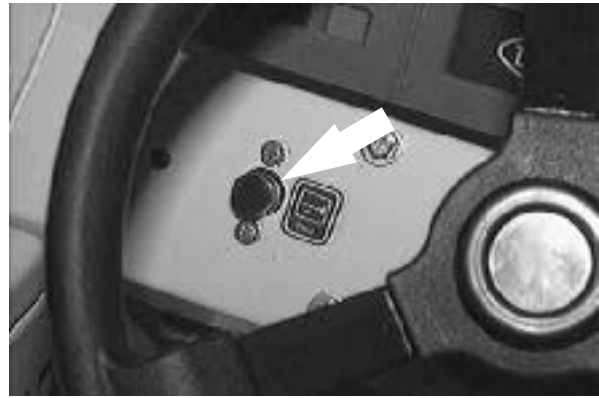

## IGNITION SWITCH

The ignition switch starts and stops the engine with a key. The operating lights will automatically turn on when the machine is started.

**FOR SAFETY: When starting machine, keep foot on brake and directional pedal in neutral.**

Start: Turn the key all the way clockwise.  
Release the key as soon as the engine starts.

Stop: Turn the key counter-clockwise.

**CAUTION:**  **LPG engine will run for a few seconds after key is turned off. Apply parking brake before leaving machine.**

*NOTE: To protect the engine's emission components on LPG powered machines, the engine will continue to operate for a few seconds after the ignition switch is turned off.*



## STEERING COLUMN TILT HANDLE

The steering wheel tilt handle adjusts the angle of the steering wheel.

Adjust: Pull out the tilt handle, move the wheel up or down, and release the tilt handle.



## OPERATION

### CHECK ENGINE LIGHT

The check engine light comes on if the engine control system detects a fault during machine operation.

If the check engine light comes on while operating the machine, contact a TENNANT service representative.



### CIRCUIT BREAKERS

The circuit breakers are resettable electrical circuit protection devices. Their design stops the flow of current in the event of a circuit overload. Once a circuit breaker is tripped, it must be reset manually. Press the reset button after the breaker has cooled down.

If the overload that caused the circuit breaker to trip is still there, the circuit breaker will continue to stop current flow until the problem is corrected.

The circuit breakers are located in the operator compartment.

The chart lists the circuit breakers and the electrical components they protect.

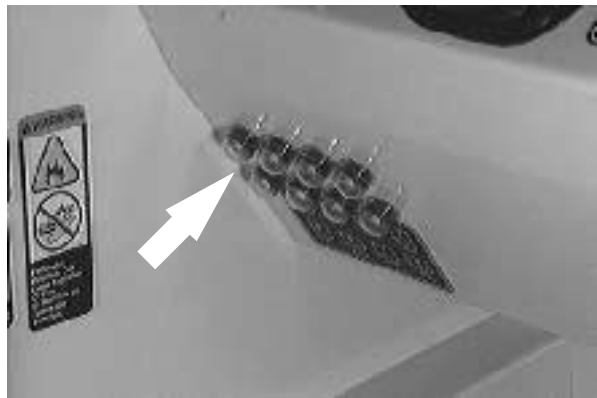

Circuit Breaker	Rating	Circuit Protected
CB-1	15 A	Ignition
CB-2	15 A	ES (option)
CB-3	15 A	Operating lights
CB-4	15 A	Back-up alarm (option)
CB-5	15 A	Horn
CB-6	5 A	Instrument panel (007000-007548)
CB-6	15 A	Instrument panel (007549- )
CB-7	15 A	Scrubbing
CB-8	15 A	Side brush (option)

**FUSES**

The *fuses* are one-time protection devices designed to stop the flow of current in the event of a circuit overload.

*NOTE: Always replace the fuse with a fuse of the same amperage.*

The *main harness fuse* is located near the relays under the front hood. Access the fuse by opening the front hood.

<b>Main Harness Fuse</b>		
<b>Fuse</b>	<b>Rating</b>	<b>Circuit Protected</b>
FU-1	15 A	Circuit board

The *engine harness fuses* are located near the engine under the engine cover. Access the fuses by opening the engine cover.

<b>Engine Harness Fuses (S/N 007000-007078)</b>		
<b>Fuse</b>	<b>Rating</b>	<b>Circuit Protected</b>
FU-1	5 A	Key switch
FU-2	20 A	Main power
FU-3	15 A	Auxiliary power
FU-4	15 A	Fuel pump

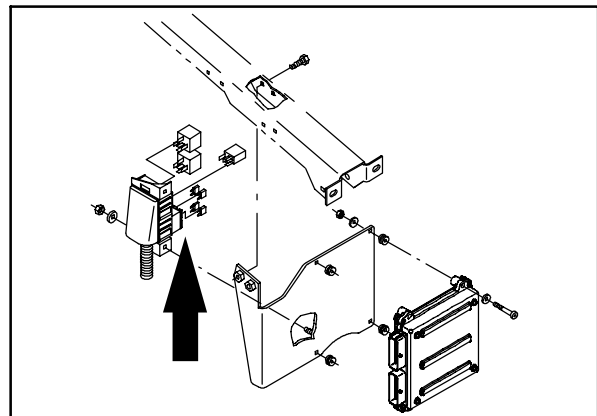

<b>Engine Harness Fuses (S/N 007079- )</b>		
<b>Fuse</b>	<b>Rating</b>	<b>Circuit Protected</b>
FU-1	5 A	Key switch
FU-2	20 A	Main power
FU-3	15 A	Auxiliary power
FU-4	15 A	Fuel pump
FU-5	50 A	Alternator

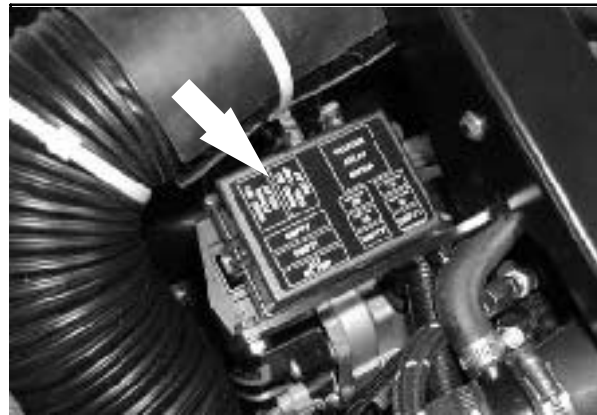

## OPERATION

### SOLUTION FLOW SWITCH (WITHOUT FaST)

The solution flow switch controls the flow of solution to the floor. The solution flow switch is only on machines without the FaST system.

Start (1): Place the solution flow switch in the middle position. Use this flow rate for smooth floors and light dirt.

Increase (2): Press the right of the solution flow switch. Use this flow rate for rough floors and heavy or compacted dirt.

Stop (0): Press the left of the solution flow switch.

*NOTE: The solution flow starts, if the solution flow switch is on, when the scrubbing operations start.*

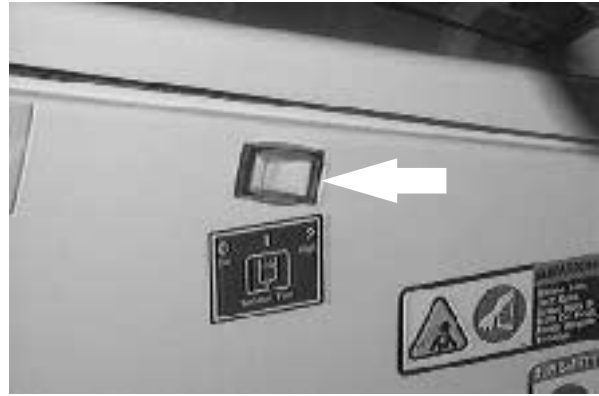

### SOLUTION FLOW SWITCH (FaST)

The FaST solution flow switch enables the FaST (Foam Scrubbing Technology) system. When the FaST system is enabled, it is turned on and off with the FaST switch. Disable the FaST system before using the machine for conventional scrubbing.

For machines with the FaST system, the FaST solution flow switch controls the flow of solution to the floor.

Start (1): Place the FaST solution flow switch in the middle position. Use this flow rate for smooth floors and light dirt.

Increase (2): Press the top of the FaST solution flow switch. Use this flow rate for rough floors and heavy or compacted dirt.

Stop (0): Press the bottom of the FaST solution flow switch.

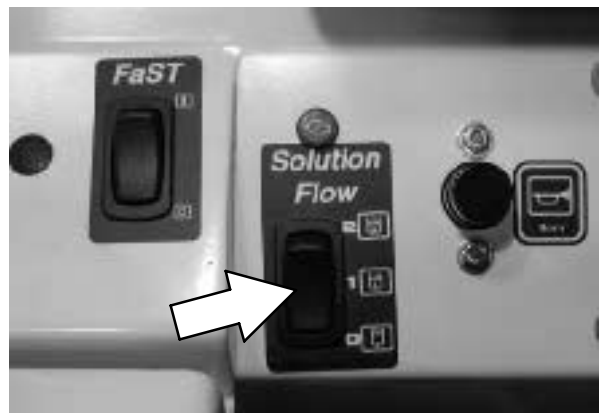

### FaST SWITCH

The FaST switch enables the FaST (Foam Scrubbing Technology) system. When the FaST system is enabled, it is turned on and off with the FaST switch. Disable the FaST system before using the machine for conventional scrubbing.

Disable FaST for conventional scrubbing: Press the bottom of switch to the **FaST system off** position.

Enable the FaST system: Press the top of switch to the **FaST system on** position.

*NOTE: The FaST system will not start until the directional pedal is pressed.*

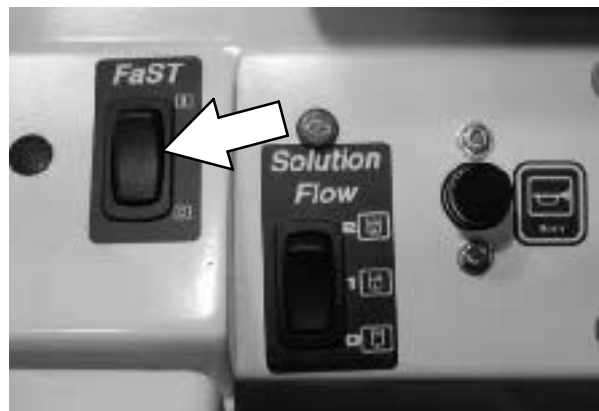



**SOLUTION TANK DRAIN HOSE**

The solution tank drain hose is used to drain the solution tank. Drain the solution tank by removing the drain hose cap from the tank access cap. Pull out the solution tank hose and remove the drain hose end cap.

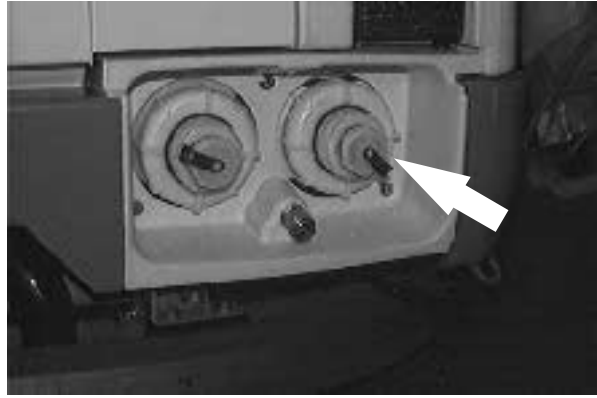
**RECOVERY TANK DRAIN HOSE**

The recovery tank drain hose is used to drain the recovery tank. Drain the recovery tank by removing the drain hose cap from the tank access cap. Pull out the recovery tank hose and remove the drain hose end cap.

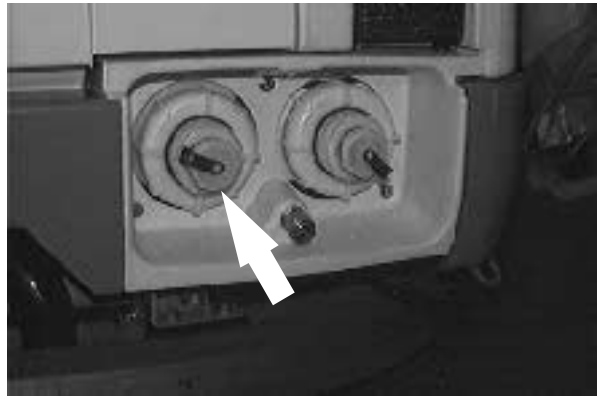

## OPERATION

### OPERATOR SEAT

The operator seat is a fixed back style with a forward-backward position adjustment.

Adjust: Pull the lever, slide the seat backward or forward to the desired position and release the lever.



Lift: Pull up on the seat mounting plate until the seat mount locks up.

Lower: Pull on the release lever and lower the seat mounting plate.

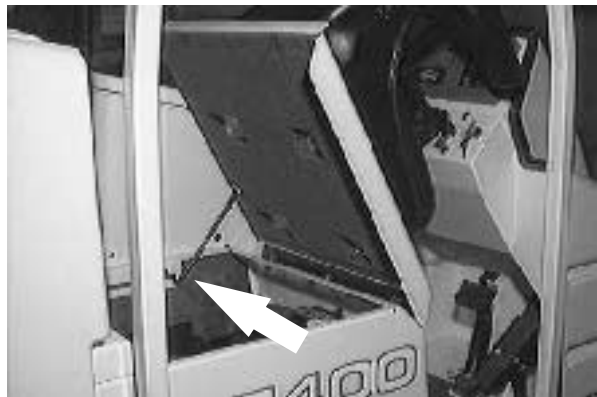

### LATCHES

The side doors, engine cover, debris tray, back grille, and solution tank covers are secured with latches.

Open the brush side doors: Push down on the door latch.

Open the engine side door: Pull out on the door latch.

Open the engine cover: Open the engine side door and pull on the latch release.

Release the debris tray: Pull down on the latch handle.

Open the back grille: Pull up on the latches.

Open the solution tank covers: Pull up on the cover latch.



---

**HOW THE MACHINE WORKS**

---

The steering wheel controls the direction of machine travel. The directional pedal controls the speed and forward/reverse direction. The brake pedal slows and stops the machine.

Water and detergent, from the solution tank, flow to the floor through a solution valve to the scrub brushes. The brushes scrub the floor. As the machine travels forward the squeegee wipes the dirty solution off the floor, which is then picked up and drawn into the recovery tank.

When using the ES mode, the solution in the recovery tank is filtered and returned to the solution tank to be reused.

When scrubbing is finished, drain and clean the recovery tank. If using the ES system, drain and clean the solution tank, clean the solution outlet filter, and clean the ES filter.

## OPERATION

### FaST SCRUBBING SYSTEM

Unlike conventional scrubbing, the FaST (Foam Scrubbing Technology) system operates by injecting the FaST PAK concentrate agent into the system with a small amount of water and compressed air. This mixture creates a large volume of expanded wet foam.

The expanded foam mixture is then dispersed onto the floor while the machine is scrubbing. When the squeegee picks up the mixture, the patented foaming agent has collapsed and is recovered into the recovery tank.

The FaST system can be used with all double scrubbing and heavy duty scrubbing applications.

Using the FaST system can increase productivity by 30% by reducing your dump/fill cycle. It will also reduce chemical usage and storage space. One FaST PAK of concentrated agent can scrub up to 1 million sq. ft.

*NOTE: Do not enable the FaST system with conventional cleaning detergents in the solution tank. Drain, rinse and refill the solution tank with clear cool water only before operating the FaST system. Conventional cleaning detergents/restorers may cause failure to the FaST solution system.*

*NOTE: Storage or transporting machines equipped with FaST in freezing temperatures requires special procedures. Check with a TENNANT representative for advice.*

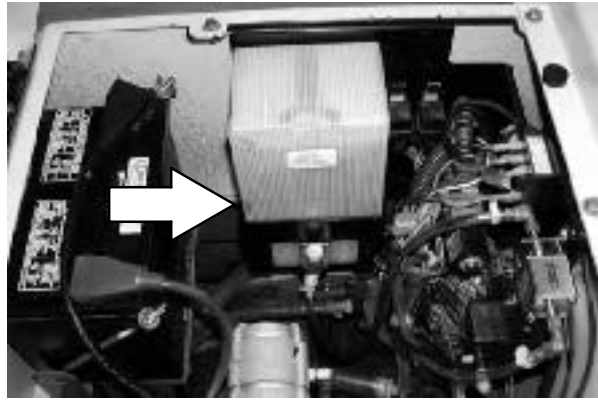

**FaST**  
Foam Scrubbing Technology

***The safe scrubbing alternative***

---

**PRE-OPERATION CHECKLIST**

---

- Check under the machine for leaks (fuel, oil, coolant, scrubbing solution).
- Check the engine air filter indicator.
- Check the engine oil level.
- Check the fuel level.
- Check the brakes and steering for proper operation.
- Check the rear squeegee for wear and proper deflection. Check the side squeegees for wear.
- Check for wire, string, or twine wrapped around the scrub brushes.
- Check the vacuum hoses for debris or obstructions.
- Check that the debris tray is empty and clean.
- ES machines. Check that the ES filter and solution outlet filter is clean.
- Check for loose fittings, or wires.
- Check the condition of the v-belt.
- Check the hydraulic oil level.
- Check the cooling system level.
- ES machines. Check detergent level in the detergent tank, fill as required.
- FAST Scrubbing: Check the FaST PAK concentrate agent level, replace carton as needed. See the INSTALLING THE FaST PAK AGENT section of the manual.
- FAST Scrubbing: Check that all conventional cleaning agents/restorers are drained and rinsed from the solution tank.
- FAST Scrubbing: Check that the solution tank is filled with **clear cool water only**.

### INSTALLING FaST PAK AGENT

*NOTE: Machine must be equipped with FaST before the FaST PAK agent can be installed.*

1. Remove the perforated knock-outs from the FaST PAK Floor Cleaning Concentrate carton. Do not remove the bag from the carton. Pull out the bag's hose connector on the bottom of the bag and remove the hose cap from the connector.

***NOTE: The FaST PAK Floor Cleaning Concentrate is specifically designed for use with the FaST system scrubbing application. NEVER use a substitute, machine damage will result.***

**FOR SAFETY: When using machine, always follow the handling instructions on chemical container.**

2. Empty the solution tank. See the DRAINING AND CLEANING THE TANKS section of the manual.

*NOTE: When scrubbing with the FaST system option, use clean water only. Do not add cleaning agents in the solution tank. Conventional cleaning agents/restorers may cause failure to the FaST solution system..*

3. Raise the seat mounting plate to access the FaST PAK carton.

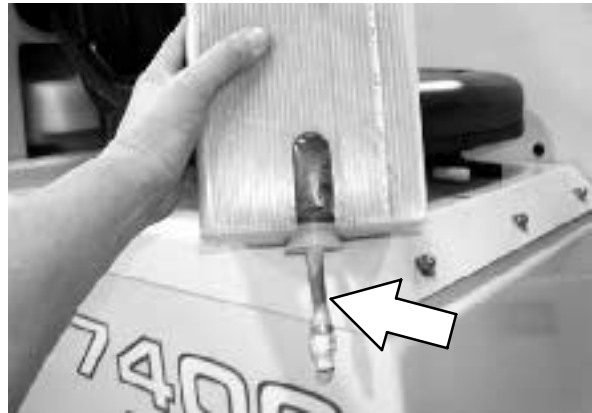

4. Connect the supply hose to the FaST PAK bag.

*NOTE: If any dried concentrate is visible on the supply hose connector or the on the FaST PAK connector, soak and clean with warm water.*

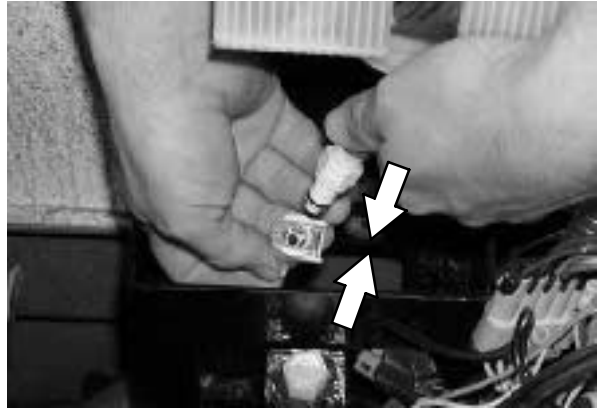

5. Place the FaST PAK carton in the carton holder under the seat mounting plate on the machine.

*NOTE: Make sure the supply hose is not pinched.*



6. Make sure to connect the supply hose onto the hose storing plug when the supply hose is not connected to the FaST PAK. This will prevent the FaST solution system from drying out and clogging up the hose.

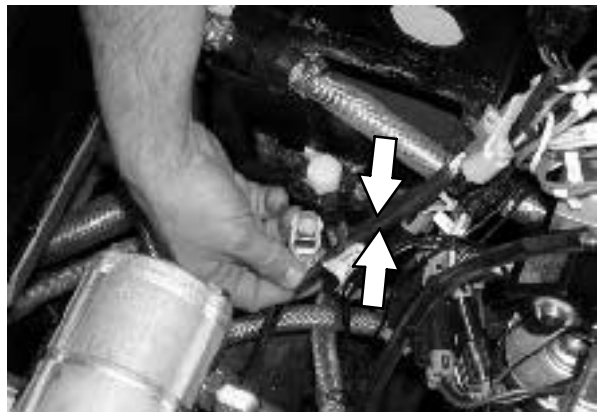

7. When replacing an empty FaST PAK carton, allow the new FaST PAK detergent to gravity feed into the system for several minutes prior to operating the FaST system. If the detergent does not flow out of the FaST PAK, simply squeeze and release the hose several times. If the previous FaST PAK was run dry, it may take up to 5-10 minutes of operation to remove any air pockets in the system before you achieve maximum foaming.

## OPERATION

### CHANGING AN LPG FUEL TANK

1. Park the machine in a designated safe area.
2. Open the machine front cover.
3. Close the tank service valve on the LPG tank.
4. Operate the engine until it stops from lack of fuel, turn the ignition switch off, then set the machine parking brake.

**FOR SAFETY: When servicing machine, Keep flames and sparks away from fuel system service area. Keep area well ventilated.**

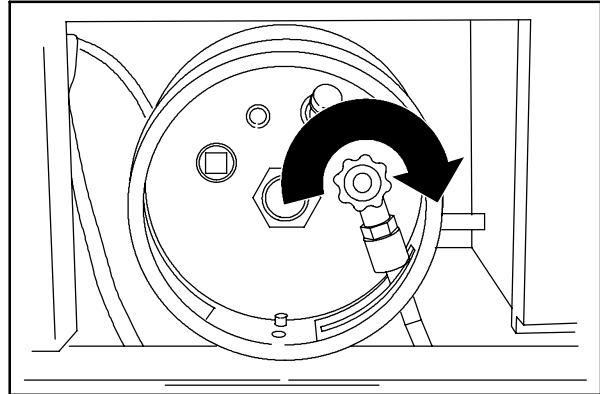

07810

5. Put on gloves and remove the quick-disconnect tank coupling.
6. Unlatch and remove the empty LPG fuel tank from the machine and store the tank in a designated, safe area.

*NOTE: Make sure the LPG fuel tank matches the fuel system (liquid tank with liquid system).*

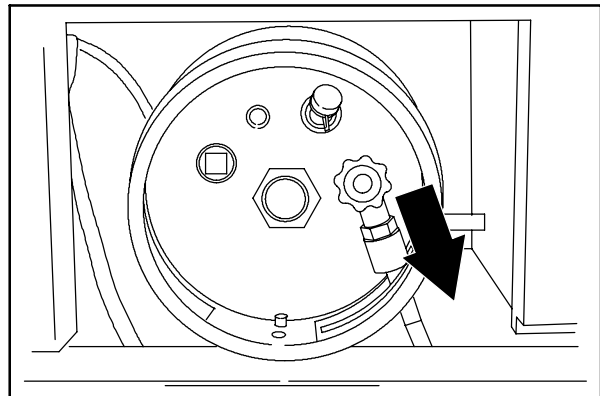

07811

7. Carefully put the filled LPG tank in the machine so that the tank centering pin enters the aligning hole in the tank collar.
8. Fasten the tank hold-down clamp to lock the tank in position.

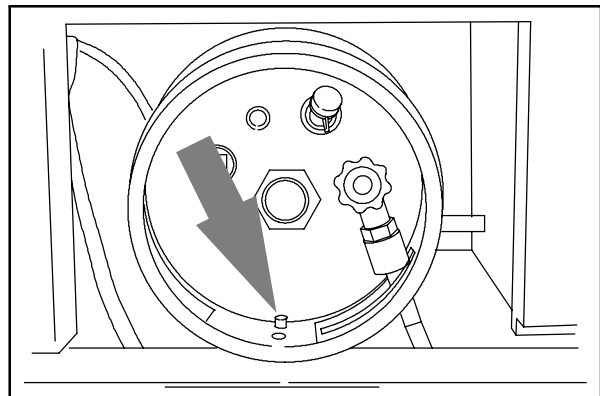

07812



9. Connect the LPG fuel line to the tank service coupling. Make sure the service coupling is clean and free of damage. Also make sure it matches the machine service coupling.

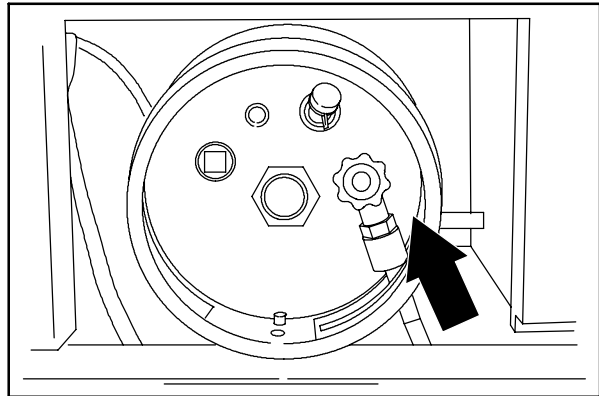

07813

10. Open the tank service valve slowly and check for leaks. Close the service valve immediately if an LPG leak is found, and tell the appropriate personnel.

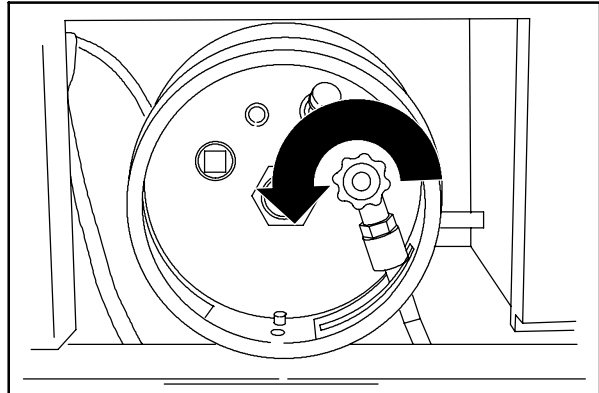

07814

**STARTING THE MACHINE**

1. LPG powered machines: Open the liquid service valve slowly.

*NOTE: Opening the service valve too quickly may cause the service check valve to stop the flow of LPG fuel. If the check valve stops the fuel flow, close the service valve, wait a few seconds and open the valve slowly again.*

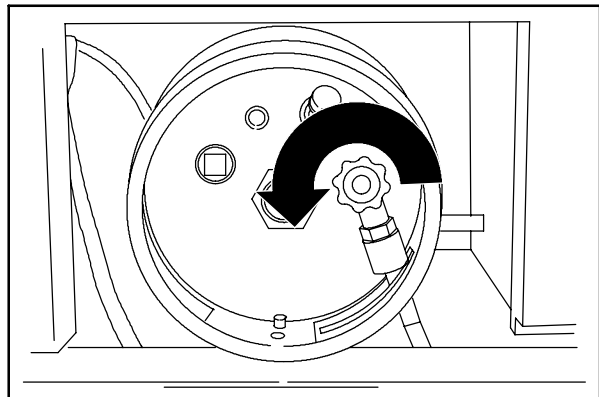

07814

2. You must be in the operator's seat with the directional pedal in neutral, and your foot on the brake pedal or with the parking brake set.

**FOR SAFETY: When starting machine, keep foot on brake and directional pedal in neutral.**

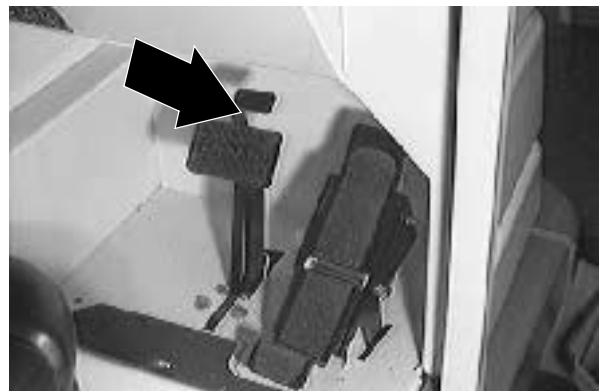

## OPERATION

3. Turn the ignition switch key clockwise until the engine starts.

*NOTE: Do not operate the starter motor for more than 10 seconds at a time or after the engine has started. Allow the starter to cool between starting attempts or damage to the starter motor may occur.*

4. Allow the engine and hydraulic system to warm up three to five minutes.

**! WARNING: Engine emits toxic gases. Severe respiratory damage or asphyxiation can result. Provide adequate ventilation. Consult with your regulatory authorities for exposure limits. Keep engine properly tuned.**

5. Release the machine parking brake.



6. Select the (Fast) engine speed with the engine speed switch.

7. Drive the machine to the solution tank filling area.

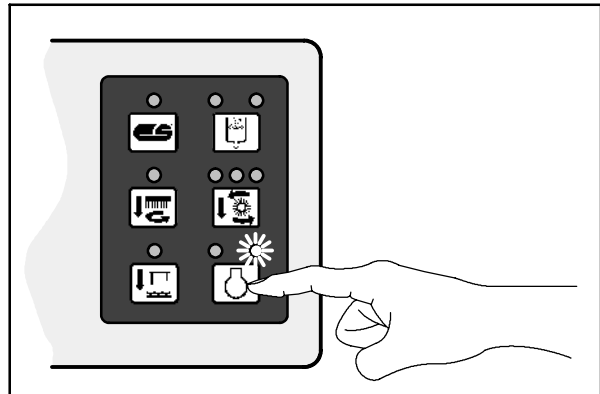

10896

---

## SCRUBBING AND BRUSH INFORMATION

---

Pick up oversized debris before scrubbing. Pick up pieces of wire, string, twine, etc., which could become wrapped around the scrubbing brushes.

Plan the scrubbing in advance. Try to arrange long runs with minimum stopping and starting. Do an entire floor or section at one time. Drive as straight a path as possible. Avoid bumping into posts or scraping the sides of the machine. Overlap the brush paths.

When scrubbing dead end aisles, start at the closed end of the aisle and scrub your way out.

Avoid turning the steering wheel too sharply when the machine is in motion. The machine is very responsive to the movement of the steering wheel. Avoid sudden turns, except in emergencies.

Adjust the machine speed, scrub brush pressure, and detergent and solution flow as required when scrubbing. Use minimum scrub brush pressure and solution flow required for the best scrubbing results. When approaching a corner, turn off the solution flow before turning the corner. Turn on the solution flow once the machine has completed the turn.

When the recovery tank is full, the recovery tank full indicator will stay lit, and the scrubbing operations will shut off. The recovery tank will have to be drained and cleaned. Then refill the solution tank with clean water and detergent and continue cleaning.

For best results, use the correct brush type for your scrubbing application. The following are recommendations for main scrubbing, and side brush applications.

**Polypropylene main scrub brush** – A general-purpose brush with stiff bristles for aggressive action on slightly compacted soilage. Works well on concrete, wood, and tile surfaces.

**Nylon main scrub brush** – Recommended for scrubbing coated floors. Cleans without scuffing.

*NOTE: Nylon scrub brushes require a different hydraulic valve configuration.*

**Super abrasive bristle main scrub brush** – Nylon fiber impregnated with abrasive grit to remove stains and soilage. Strong action on any surface, performing well on buildup, grease, or tire marks.



## OPERATION

**Polypropylene side scrub brush** – A general-purpose brush with stiff bristles for aggressive action on slightly compacted soilage. Works well on concrete, wood, and tile surfaces.

**Nylon side scrub brush** – Recommended for scrubbing coated floors. Cleans without scuffing.

**Super abrasive bristle side scrub brush** – Nylon fiber impregnated with abrasive grit to remove stains and soilage. Strong action on any surface, performing well on buildup, grease, or tire marks.



---

## FILLING THE TANKS

---

1. Start the engine.



2. Drive the machine to the filling site.

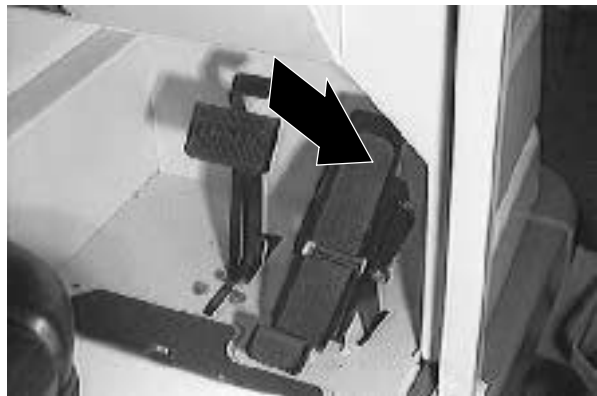

3. Shut the engine off.
4. Set the parking brake.

**FOR SAFETY: Before leaving or servicing machine; stop on level surface, set parking brake, turn off machine and remove key.**



5. **CONVENTIONAL SCRUBBING:** Open one of the solution tank covers. Start filling the solution tanks with water. Pour the required amount of detergent into the solution tanks when they are about one-half full. Fill the solution tanks to 75 mm (3 in) below the tank openings.

*NOTE: Floor conditions, water condition, amount of soilage, type of soilage, and brush action all play an important role in determining the type and concentration of detergent used. For specific recommendations, contact your Tennant representative.*



**WARNING: Flammable materials can cause an explosion or fire. Do not use flammable materials in tank(s).**

**FOR SAFETY: Follow mixing and handling instructions on chemical containers.**

6. **FaST SCRUBBING:** Open the solution tank covers and fill the solution tanks to 75 mm (3 in) below the tank openings with cool clear water only. Do not add cleaning detergents.

**NOTE: When cleaning using FaST, USE CLEAR COOL WATER ONLY. DO NOT add cleaning agents in solution tank. Conventional cleaning agents/restorers may cause failure to the FaST solution system.**

ES mode (option): Lift up the operator seat. Remove the detergent tank lid and pour the required amount of detergent into the tank. Put the lid back on the detergent tank and lower the operator seat.



**WARNING: Flammable materials can cause an explosion or fire. Do not use flammable materials in tank(s).**

*NOTE: Floor conditions, water condition, amount of soilage, type of soilage, and brush action all play an important role in determining the type and concentration of detergent used. For specific recommendations, contact your Tennant representative.*



## OPERATION

ES mode with auto-fill (option): Connect the hose from the water source to the auto-fill connection on the machine. Turn the ignition key to the on position and turn on the water source. The auto-fill will automatically fill the tanks to the proper level for ES operation and automatically shut-off.

ES mode without auto-fill: The ES tanks can also be filled manually by filling the solution tanks to 75 mm (3 in) below tank openings, and filling the recovery tank half full.

**NOTE:** If you **do not** want to use the ES system, do not put any water in the recovery tank. Turn off the ES switch.

7. Close the tank covers.

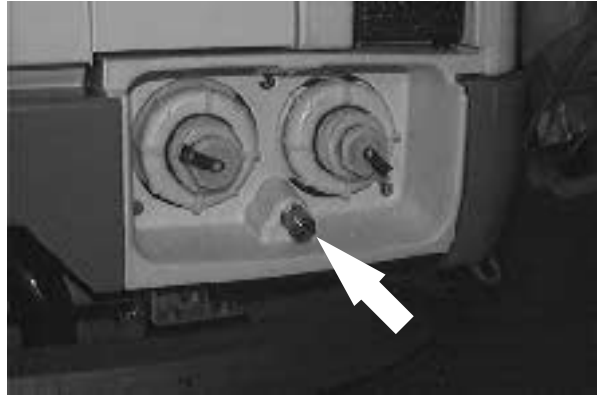

---

## SCRUBBING

---

1. Start the engine.

**FOR SAFETY:** When starting machine, keep foot on brake and directional pedal in neutral.

2. Drive the machine to the area to be cleaned.



3. FaST SCRUBBING: Press the FaST switch to the FaST system on position and press the FaST solution flow switch to the desired solution flow. See the SOLUTION FLOW SWITCH (FaST) section of the manual.

**NOTE:** Leave the FaST switch in the CONVENTIONAL SCRUBBING position if not using the FaST system.

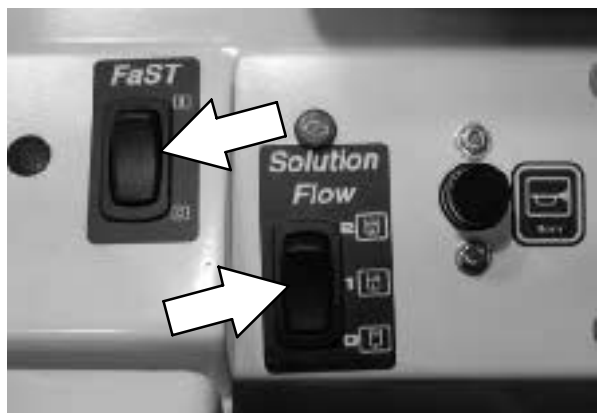

4. CONVENTIONAL SCRUBBING: Adjust the solution flow to the floor as needed. See the SOLUTION SWITCH (WITHOUT FaST) section of the manual.

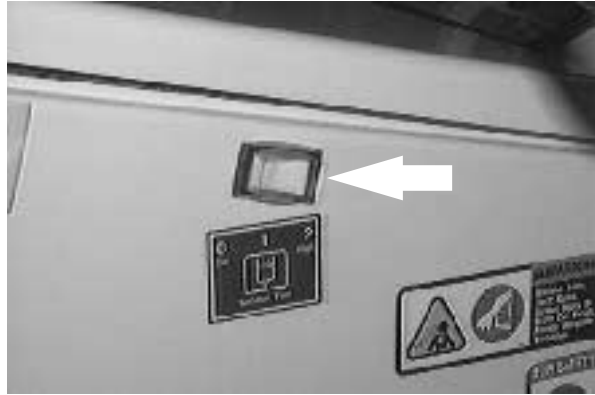

5. Press the scrub switch to start the scrubbing operations.

**⚠ WARNING: Flammable materials or reactive metals can cause an explosion or fire. Do not pickup.**

As long as the machine is not in reverse, the scrub head will lower and the scrub brushes will start. The rear squeegee will automatically lower and the vacuum fan will start. The solution flow will start, if the solution flow switch is on. The optional side brush will lower and turn on, if the switch is on. Also, the optional ES system and detergent pump will start, if the switches are on. The engine speed will change to (Fast).

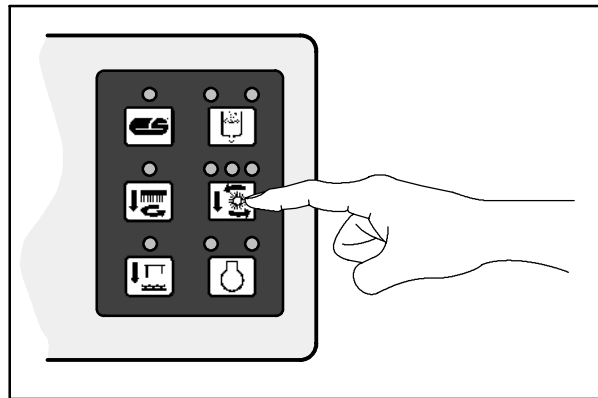

10897

## OPERATION

*NOTE: If you **do not** want to use the ES system, press the ES switch so the indicator above the switch is off.*

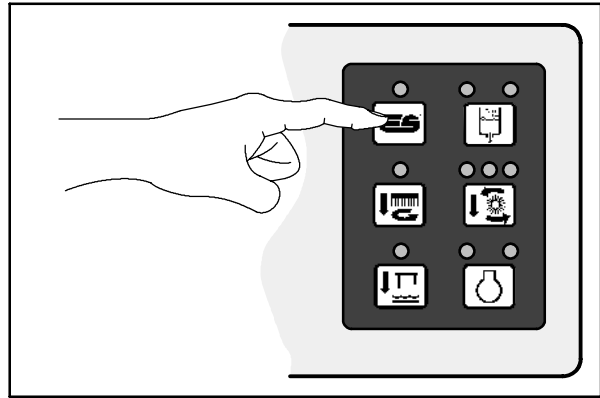

10898

*Press and hold the detergent switch until both indicator lights are off. Turn off the detergent pump only if detergent has been added to the solution tank.*

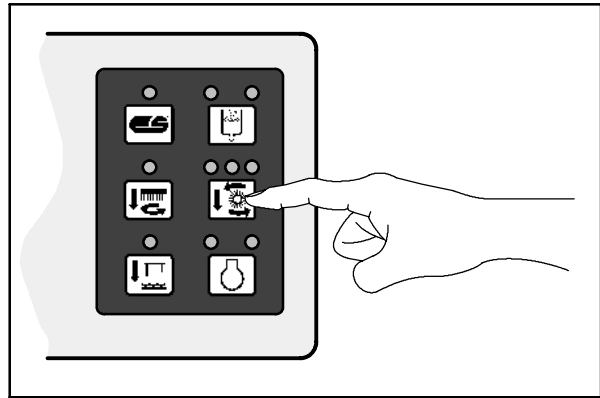

10897

6. Adjust the brush pressure for the cleaning application.

The brush pressure has three positions. Under normal conditions, the brush pressure should be set in the minimum setting. Under heavy grime conditions, the brush pressure should be set in the maximum setting.

7. Drive the machine forward and scrub as required.

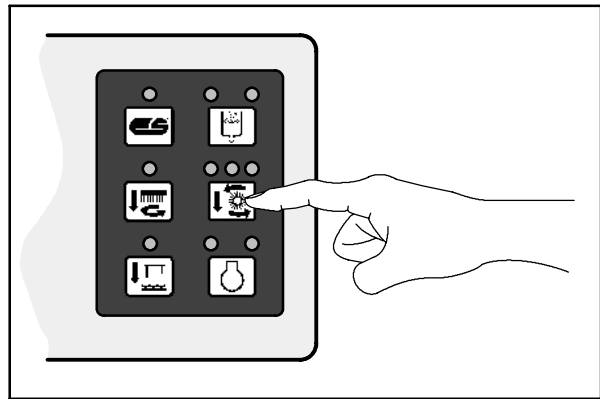

10897



---

## DOUBLE SCRUBBING

---

Double scrubbing is a method for removing heavy soil accumulations. This is done by making two passes over the area, to be cleaned, with the machine.

Double scrubbing can be performed using the FaST SCRUBBING SYSTEM or CONVENTIONAL SCRUBBING methods.

First, make a pass over the area scrubbing with the squeegee up. This dispenses solution over the area allowing the solution to soak on the floor. Use the maximum solution and detergent flow settings. Use a higher brush pressure setting. Let the solution remain on the floor for 5 to 15 minutes. Then make a second scrubbing pass with the squeegee down.

**FOR SAFETY: When using machine, go slow on inclines and slippery surfaces.**

This is not recommended in areas where the cleaning solution will run under racks or damage products.

---

## STOP SCRUBBING

---

1. Press the scrub switch to stop the scrubbing operations.

The scrub brushes will stop and the scrub head will raise. The optional side brush will stop and raise. The ES detergent pump will stop, and the solution flow will stop, the FaST system will stop. After a short delay, the rear squeegee will automatically raise and the vacuum fan will stop. The engine speed will remain at (Fast).

Drive the machine forward until the vacuum fan shuts off.

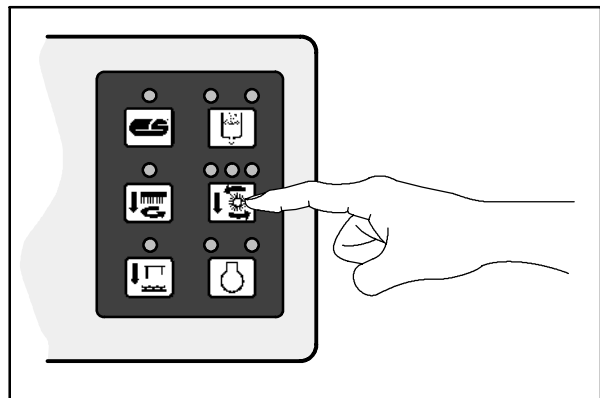

10897

## DRAINING AND CLEANING THE TANKS

---

When you are finished scrubbing or the recovery tank full light comes on, the recovery tank should be drained and cleaned. The solution tank then can be filled again for additional scrubbing.

If you used the machine in ES mode, the solution tank should also be drained and cleaned when you are finished scrubbing.

1. Stop scrubbing.
2. Drive the machine next to an appropriate disposal site.
3. Shut the engine off.



4. Set the parking brake.

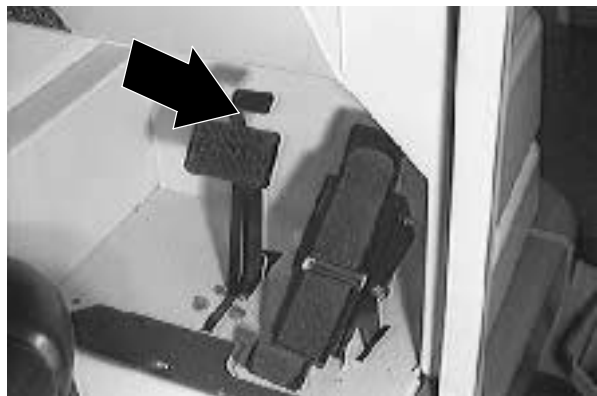

5. Unscrew the drain hose cap from the access cap of the recovery tank drain.
6. Pull out and place the drain hoses next to the floor drain. Remove the drain end cap from the hose. Stand back, the solution rushes out of the drain hoses.

*NOTE: To prevent the solution from rushing out of the recovery tank drain hose, leave the engine on and lower the rear squeegee to start up the vacuum fan, before removing the drain hose end cap. Once the drain hose is placed next to the floor drain, raise the squeegee and shut off the engine. Be sure to set the machine parking brake.*

For machines with the positive solution control drain, connect the hose. Place the hose end next to the floor drain and open the drain valve.

7. Open the recovery tank covers.
8. Spray the inside of the recovery tank with clean water.

9. Remove the large drain cap and flush out the bottom on the recovery tank.

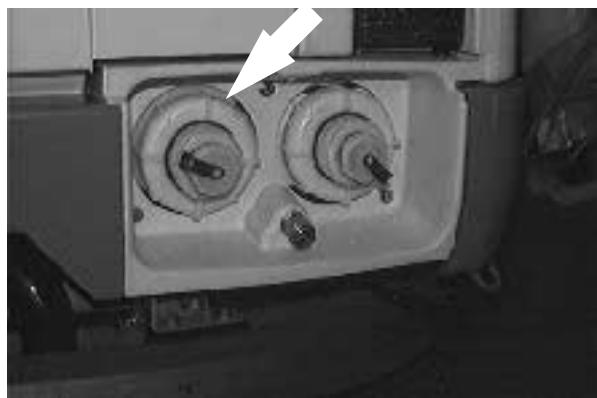
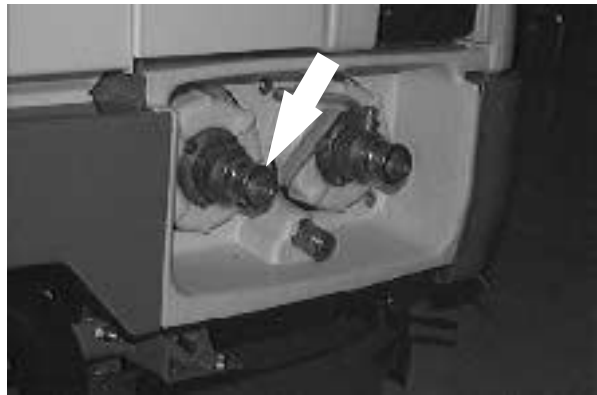
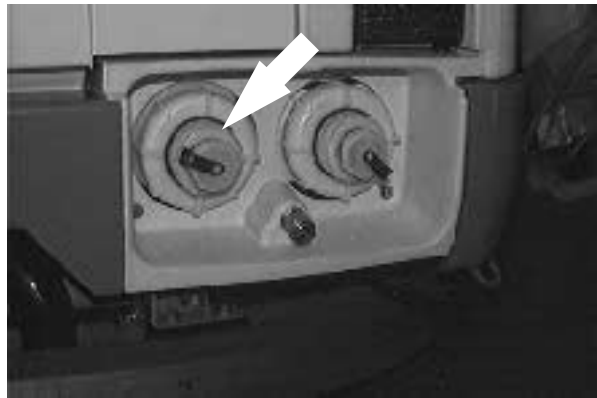

## OPERATION

10. ES mode: Clean the ES filter. If the filter can't be rinsed off through the right recovery tank fill opening, the filter can be removed from the recovery tank by disconnecting the ES pump wire and solution hose, and unscrewing the ES pump cap from the recovery tank.

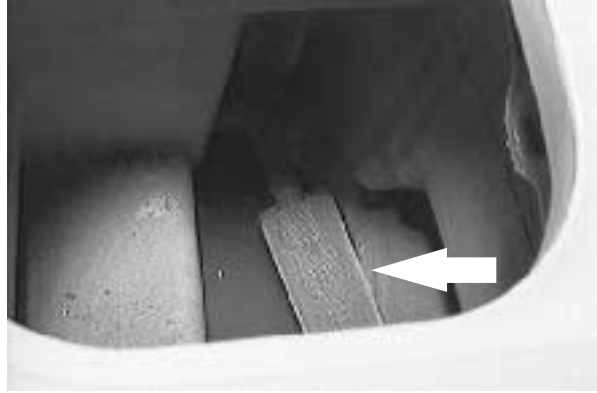

11. ES mode: Drain the solution tank. Flush out the solution tank with clean water. Rinse the solution outlet filter at the bottom of the tank through the drain access.
12. Close the tank covers.
13. Replace the drain caps and drain hoses.



14. Unlatch the rear squeegee and tray assembly. Swing out the assembly.

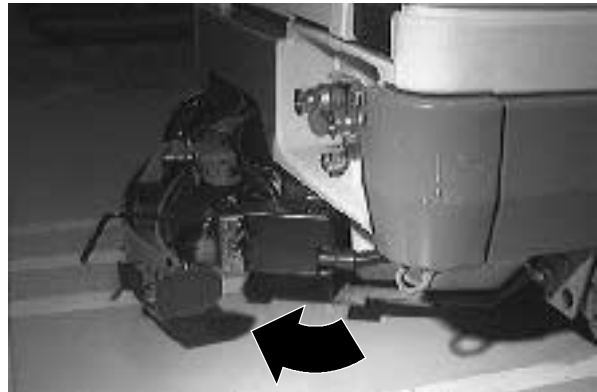

15. Disconnect the vacuum hose from the side of the debris tray. Slide the debris tray out, empty and clean it.
16. Clean the debris screen located at the bottom of the tray.
17. Slide the debris tray into the rear squeegee and tray assembly.
18. Connect the vacuum hose. Swing the assembly back into place and latch.



---

**STOP THE MACHINE**

---

1. Stop scrubbing and drive the machine forward until the vacuum fan shuts off.
2. Take your foot off the directional pedal. Step on the brake pedal.



3. Select the (Idle) position with the engine speed switch.

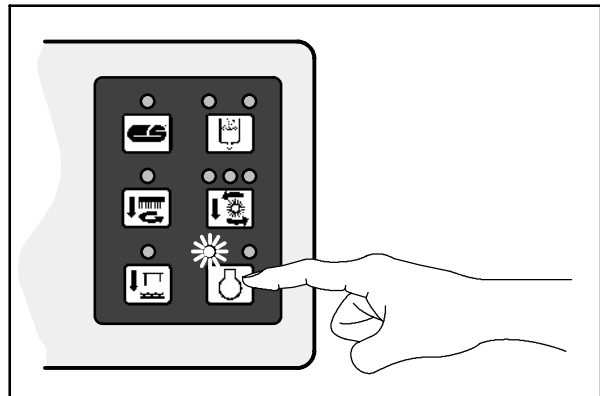

10900

4. Set the machine parking brake.

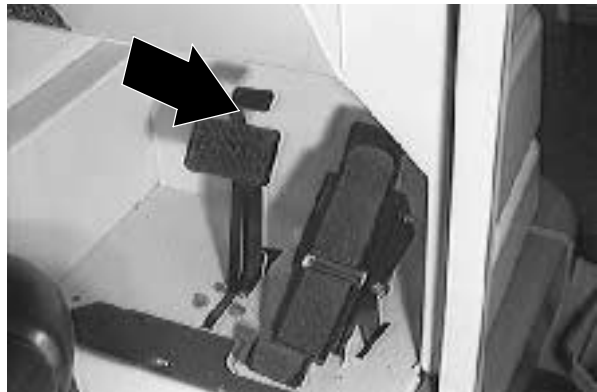

## OPERATION

5. Turn the ignition switch key counter-clockwise to stop the engine. Remove the switch key.

*NOTE: To protect the engine's emission components on LPG powered machines, the engine will continue to operate for a few seconds after the ignition switch is turned off.*

**FOR SAFETY: Before leaving or servicing machine; stop on level surface, set parking brake, turn off machine and remove key.**



6. LPG powered machines: Close the LPG tank's liquid service valve.

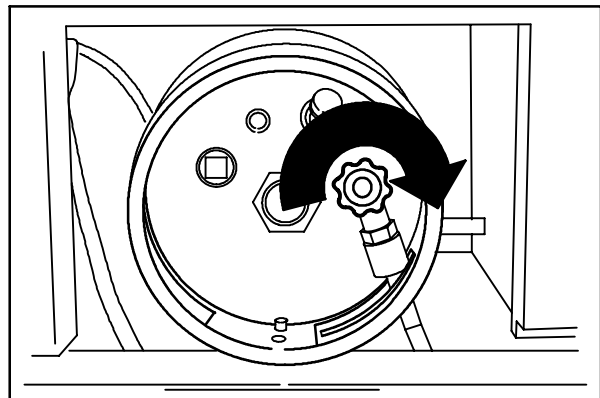

07810

---

**POST-OPERATION CHECKLIST**

---

- Check the brush adjustment. See *TO CHECKING AND ADJUSTING SCRUB BRUSH PATTERN* in *MAINTENANCE*.
- Check for wire, string, or twine wrapped around the scrub brushes.
- Check the squeegees for wear or damage.
- Drain and clean the recovery tank.
- ES mode: Drain and clean the solution tank and clean the solution outlet filter. Clean the ES filter.
- Check the vacuum hoses for debris or obstructions.
- Remove and clean the debris tray.
- LPG powered machine: Check to make sure the LPG tank service valve is closed.
- Check for fuel odor that indicates a fuel leak.
- Check under the machine for leak (fuel, oil, coolant, scrubbing solution).
- Check the service records to determine the maintenance requirements.
- FaST Scrubbing: If FaST PAK is empty after scrubbing, install a new FaST PAK or connect supply hose to the storage plug.

---

**OPERATION ON INCLINES**

---

Drive the machine slowly on inclines. Use the brake pedal to control machine speed on descending inclines. Scrub with the machine up inclines rather than down inclines.

The maximum rated incline for scrubbing with the machine is 6°. The maximum rated incline during transport of the machine is 8°.

**FOR SAFETY: When using machine, go slow on inclines and slippery surfaces.**

## OPTIONS

### VACUUM WAND

The vacuum wand uses the machine's vacuum system. The vacuum hose and wand allows pick-up of spills that are out of reach of the machine.

**⚠ WARNING: Flammable materials or reactive metals can cause an explosion or fire. Do not pickup.**

1. Stop the machine within reach of the area to be vacuumed.
2. Lower the squeegee and shut the engine off.

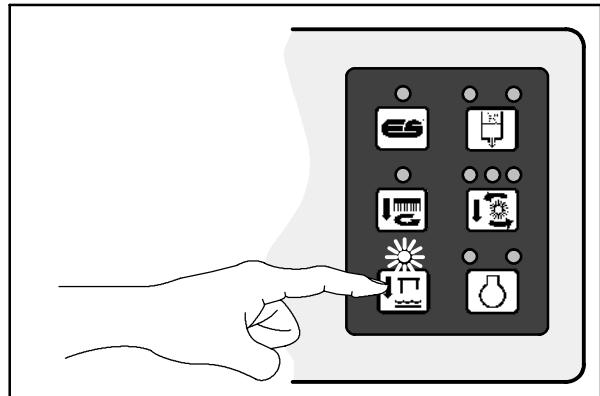

10901



3. Set the machine parking brake.

**FOR SAFETY: Before leaving or servicing machine; stop on level surface, set parking brake, turn off machine and remove key.**





4. Remove the squeegee suction hose from the rear squeegee and connect the vacuum hose.



5. Put together the wand and the wand hose.
6. Start the engine.



7. Select the (Fast) engine speed with the engine speed switch.

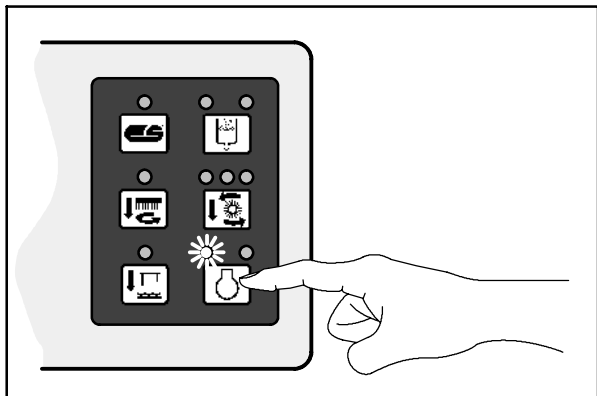

10900

8. Lower the squeegee to turn the vacuum system on.

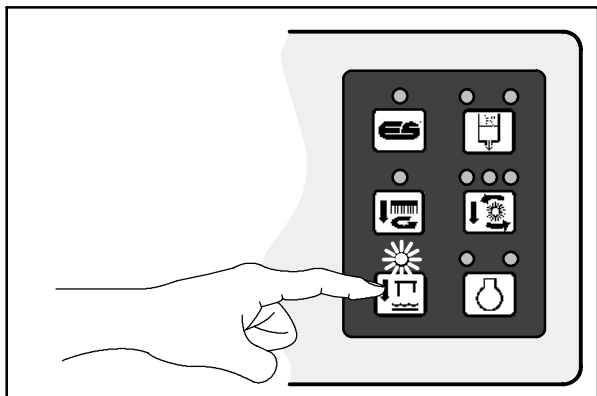

10901

## OPERATION

9. Vacuum the floor.

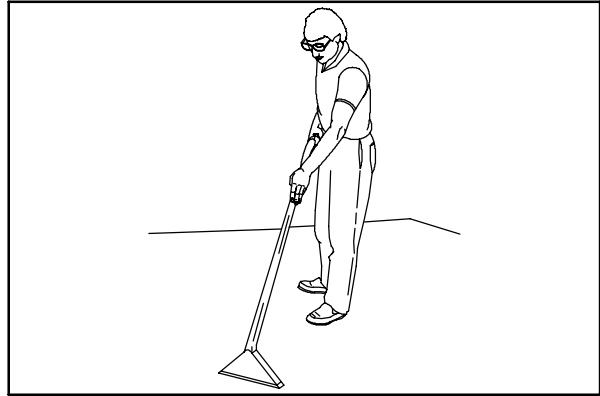

06599

10. Shut the engine off.



11. Remove the vacuum hose from the squeegee suction hose and connect the squeegee suction hose to the rear squeegee.
12. Put the vacuum wand and hose in the mounting clips.

**MACHINE TROUBLESHOOTING**

Problem	Cause	Remedy	
Trailing water – poor or no water pickup.	Worn rear squeegee blades.	Rotate or replace squeegee blades.	
	Rear squeegee out of adjustment.	Adjust rear squeegee.	
	Worn side squeegee blades.	Replace side squeegee blades.	
	Side squeegees out of adjustment.	Adjust side squeegees.	
	Too much solution flow to floor.	Reduce solution flow to floor.	
	Vacuum hose clogged.	Flush vacuum hoses.	
	Recovery tank full.		Drain recovery tank.
			Check ES filter
	Float stuck shutting off vacuum.	Clean float.	
	Debris caught on rear squeegee.	Remove debris.	
	Foam filling recovery tank.	Empty recovery tank; use less or change detergent.	
	Vacuum hose to rear squeegee disconnected or damaged.	Reconnect or replace vacuum hose.	
	Vacuum fan to recovery tank hose damaged.	Replace hose.	
Little or no solution flow to the floor.	Solution tank empty.	Fill solution tank.	
	Solution supply lines plugged.	Flush solution supply lines.	
	ES switch off.	Turn ES switch on.	
	Solution flow switch turned off.	Turn solution flow switch on.	
Poor scrubbing performance.	Debris caught on scrub brushes.	Remove debris.	
	Improper detergent or brushes used.	Check with Tennant representative for advice.	
	Worn scrub brushes.	Replace scrub brushes.	
ES system does not fill solution tank.	Clogged solution pump or lines.	Flush ES system.	
	ES float stuck.	Clean floats of debris.	
	Clogged ES pump filter.	Clean filter.	
	Water levels too low in tanks.	Add water.	

## OPERATION

Problem	Cause	Remedy
FaST System does not operate	FaST switch is set for Conventional scrubbing	Set the FaST switch for FaST system scrubbing
	FaST circuit breaker tripped	Determine cause and reset the 10A circuit breaker button
	Clogged FaST PAK supply hose and/or connector	Soak connector and hose in warm water and clean
	FaST PAK carton is empty or not connected	Replace FaST PAK carton and/or connect supply hose
	FaST system is not primed	To prime, operate the FaST solution system for 5 to 10 minutes.
	Clogged flow control orifice/screen	Remove and clean orifice/screen
	Faulty pump or air compressor	Contact TENNANT representative
	Clogged filter screen	Drain solution tank, remove and clean filter screen
	Faulty detergent timer module	Contact Tennant representative
	FaST solution flow switch is off	Turn FaST solution flow switch on



**MAINTENANCE**

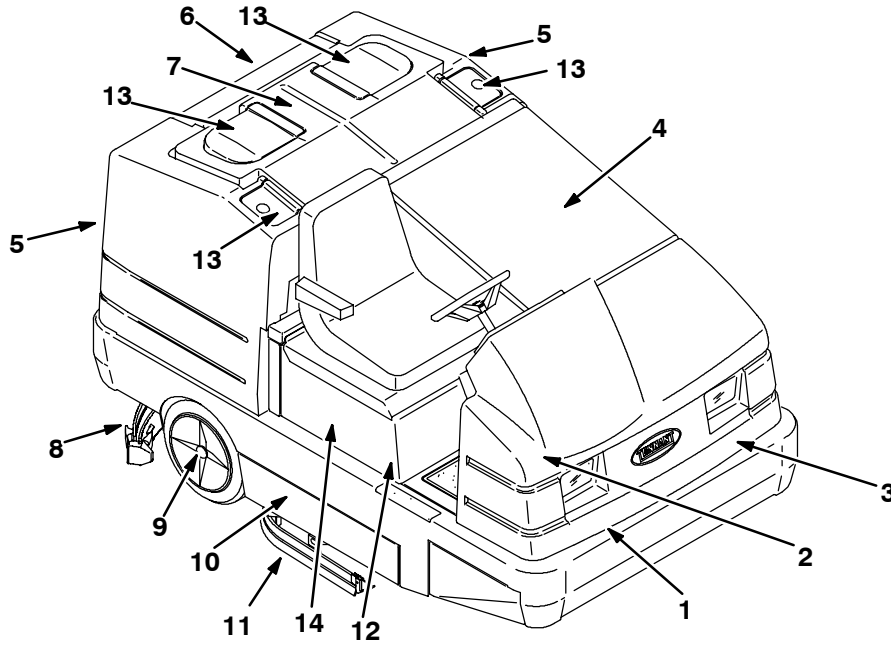

10703

**MAINTENANCE CHART**

*NOTE: Check procedures indicated (■) after the first 50-hours of operation.*

Interval	Key	Description	Procedure	Lubricant/ Fluid	No. of Service Points
Daily	4	Engine	Check indicator	-	1
			Empty dust cap	-	1
			Check oil level	EO	1
			Check coolant level in reservoir	WG	1
	8	Rear Squeegee	Check for damage and wear	-	1
			Check deflection	-	1
	11	Side Squeegees	Check for damage and wear	-	2
	10	Scrub brushes	Check for damage and wear	-	1
	7	Recovery tank	Clean	-	1
7	Recovery tank, ES mode	Clean ES filter	-	1	
5	Solution tank, ES mode	Clean	-	1	
14	FaST PAK supply hose and connector	Clean and connect hose to storing plug when not in use	-	1	
50 Hours	10	Scrub brushes	Rotate end-for-end or front-to-rear	-	1
	14	FaST Filter screen	Clean	-	1
	10	FaST spray tube	Clean	-	1
100 Hours	6	Radiator	Clean core exterior	-	1
			Check coolant level	WG	1
	4	Engine	Change oil and filter element	EO	1
			Check fan belt tension	-	1
13	Cover seals	Check for damage and wear	-	4	

Interval	Key	Description	Procedure	Lubricant/ Fluid	No. of Service Points
100 Hours	4	Engine (009000- )	Drain oil from electronic pressure regulator	-	1
100 Hours	3	Hydraulic fluid reservoir	Check fluid level	HYDO	1
	-	Tires	Check for damage	-	3
	8	Rear squeegee	Check leveling	-	1
	10	Scrub brush idlers	Lubricate	SPL	2
	10	Scrub head skirts	Check for damage and wear	-	2
	-	Side brush skirt	Check for damage and wear	-	1
	200 Hours	6	Radiator hoses and clamps	Check for tightness and wear	-
2		Parking brake	Check adjustment	-	1
2		Brake pedal	Check and adjust travel	-	1
1		Front wheel support bearings	Lubricate	SPL	2
14		FaST Air filter	Clean	-	1
400 Hours	9	Rear wheel bearings	Check, lubricate, and adjust	SPL	2
	4	Engine	Clean or replace and adjust spark plugs	-	4
			Clean PCV hoses	-	2
			Replace fuel filter element (LPG)	-	1
			Replace air filter	-	1
800 Hours	3	Hydraulic reservoir	Replace filler cap	-	1
			Replace suction strainer	-	1
			Change hydraulic fluid	HYDO	1
	4	Engine	Check timing belt	-	1
			Replace fuel filter (Gas)	-	1
	4	Hydraulic fluid filter	Change filter element	-	1
	-	Hydraulic hoses	Check for wear and damage	-	All
	6	Cooling system	Flush	WG	1
	1	Propelling motor	■Torque shaft nut	-	1
	1	Front wheel	■Torque wheel nuts	-	1
	12	Battery	■Clean and tighten battery cable connections	-	1
2000 Hours	4	Engine	Replace timing belt	-	1

**LUBRICANT/FLUID**

EO . . . . Engine oil, 10W30 SAE-SG/SH rated

HYDO . . . Tennant or approved hydraulic fluid

WG . . . . Water and permanent-type ethylene glycol anti-freeze, -34° C (-30° F)

SPL . . . . Special lubricant, Lubriplate EMB grease (TENNANT part no. 01433-1)

DW . . . . Distilled water

*NOTE: More frequent intervals may be required in extremely dusty conditions.*

## LUBRICATION

### ENGINE

Check the engine oil level daily. Change the engine oil and oil filter every 100 hours of machine operation. Use 10W30 SAE-SG/SH rated engine oil.

Fill the engine with oil to the level indicated on the oil dipstick. The engine oil capacity is 3.5 L (3.7 qt) including the oil filter.

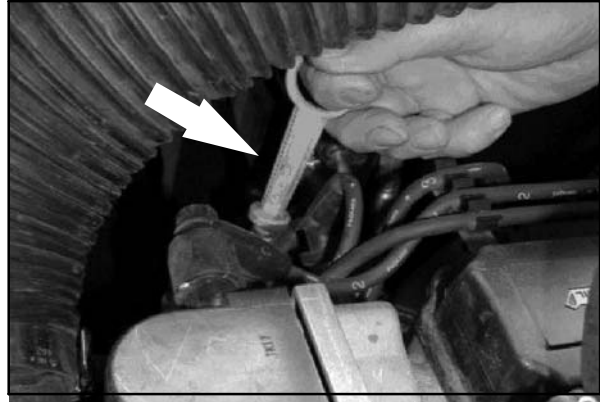

### REAR WHEEL BEARINGS

Inspect the rear wheel bearings for seal damage, and repack and adjust every 400 hours of operation. Use Lubriplate EMB grease (Tennant part number 01433-1).



### FRONT WHEEL SUPPORT BEARING

The front wheel support pivots the front wheel. The front wheel support bearings must be lubricated every 200 hours of operation. Use Lubriplate EMB grease (Tennant part no. 01433-1).

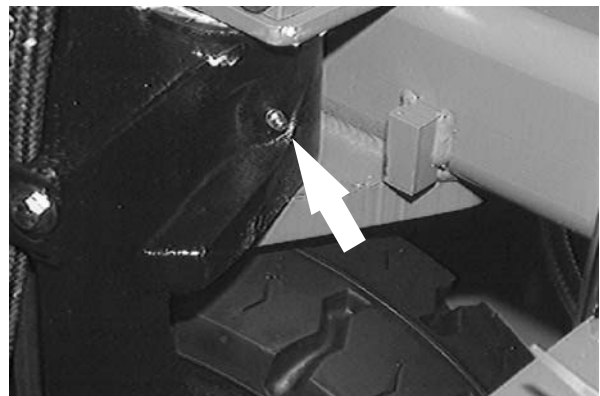



**SCRUB BRUSH IDLER**

Each scrub brush idler has one grease fitting. The scrub brush idlers must be lubricated every 100 hours of operation. Use Lubriplate EMB grease (Tennant part no. 01433-1).

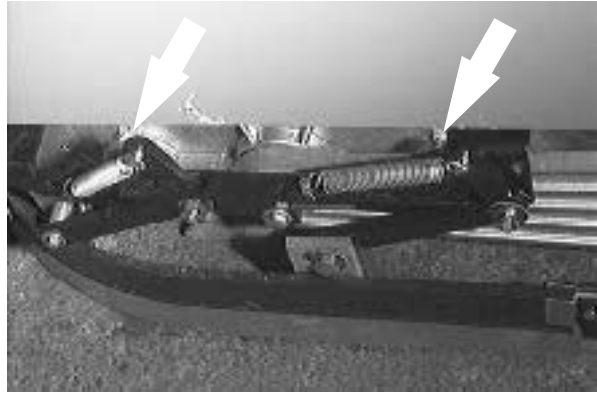

**HYDRAULICS**

**HYDRAULIC FLUID RESERVOIR**

The reservoir is located in front left corner of the machine.

Mounted on top of the reservoir is a filler cap with a built-in breather and fluid level dipstick. Replace the cap every 800 hours of operation.

Check the hydraulic fluid level at operating temperature every 100 hours of operation. The end of the dipstick is marked with FULL and ADD levels to indicate the level of hydraulic fluid in the reservoir.

Lubricate the filler cap gasket with a film of hydraulic fluid before putting the cap back on the reservoir.

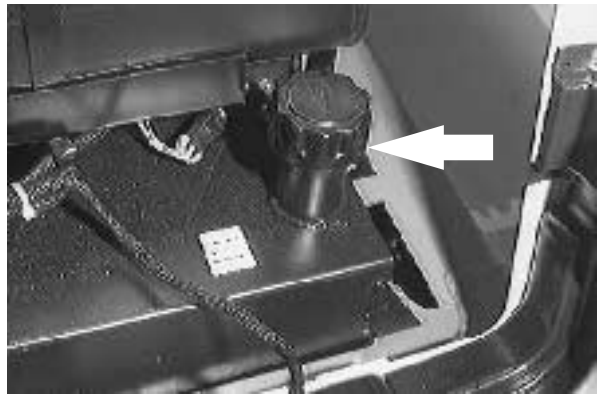

**ATTENTION! Do not overfill the hydraulic fluid reservoir or operate the machine with a low level of hydraulic fluid in the reservoir. Damage to the machine hydraulic system may result.**

Drain and refill the hydraulic fluid reservoir with new hydraulic fluid every 800 hours of operation.

The hydraulic fluid filter is located at the bottom of the engine compartment. Replace the filter element every 800 hours of operation.

The reservoir has a built-in strainer outlet that filters hydraulic fluid before it enters the system. Replace the strainer every 800 hours of operation.

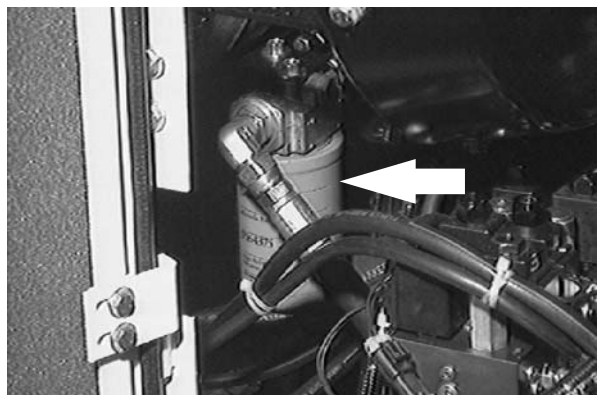

## HYDRAULIC FLUID

The quality and condition of the hydraulic fluid play a very important role in how well the machine operates. Tennant hydraulic fluid is specially selected to meet the needs of Tennant machines.

Tennant hydraulic fluids provide a longer life for the hydraulic components. There are two fluids available for different temperature ranges:

Tennant part no.	Ambient Temperature
65869	above 7° C (45° F)
65870	below 7° C (45° F)

The higher temperature fluid has a higher viscosity and should not be used at the lower temperatures. Damage to the hydraulic pumps may occur because of improper lubrication.

The lower temperature fluid is a thinner fluid for colder temperatures.

If a locally-available hydraulic fluid is used, make sure the specifications match Tennant hydraulic fluid specifications. Using substitute fluids can cause premature failure of hydraulic components.

**ATTENTION! Hydraulic components depend on system hydraulic fluid for internal lubrication. Malfunctions, accelerated wear, and damage will result if dirt or other contaminants enter the hydraulic system.**

## HYDRAULIC HOSES

Check the hydraulic hoses every 800 hours of operation for wear or damage.

Fluid escaping at high pressure from a very small hole can be almost invisible, and can cause serious injuries.

See a doctor at once if injury results from escaping hydraulic fluid. Serious infection or reaction can develop if proper medical treatment is not given immediately.

**FOR SAFETY: When servicing machine, use cardboard to locate leaking hydraulic fluid under pressure.**

If you discover a fluid leak, contact your mechanic/supervisor.

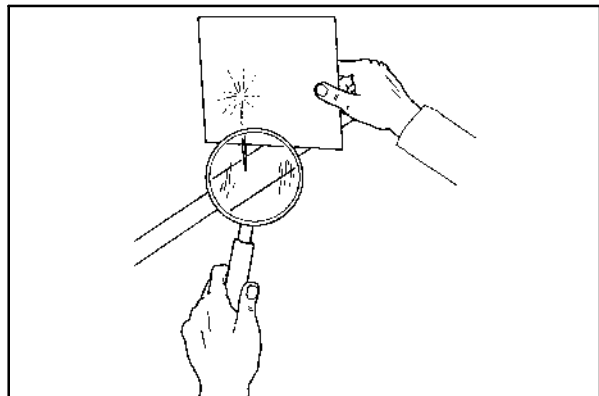

00002

---

**ENGINE**

---

**COOLING SYSTEM**

Check the coolant level in the reservoir daily. The coolant level must be between the two indicator marks when the engine is cold.



Check the radiator coolant level every 100 hours of operation. Use a clean water mixed with a permanent-type, ethylene glycol antifreeze to a  $-34^{\circ}\text{C}$  ( $-30^{\circ}\text{F}$ ) rating.

**FOR SAFETY: When servicing machine, avoid contact with hot engine coolant.**



## MAINTENANCE

The coolant system must be completely filled with coolant to keep the engine from overheating. When filling the radiator with coolant, use the drain cocks to ensure that all the air is out of the system.

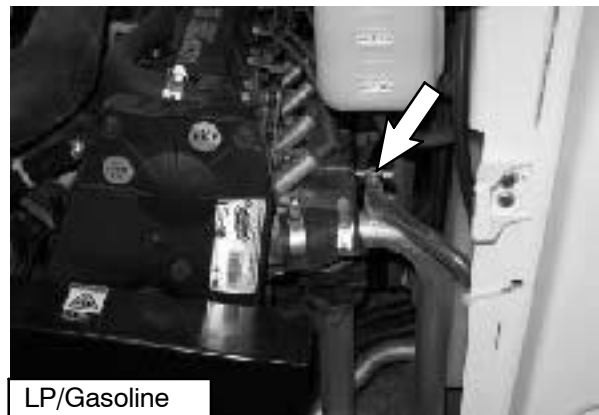
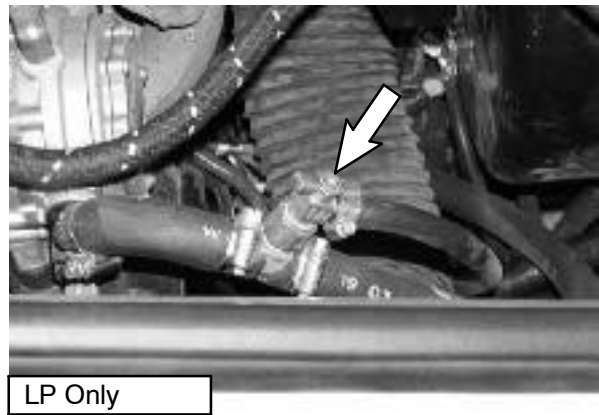
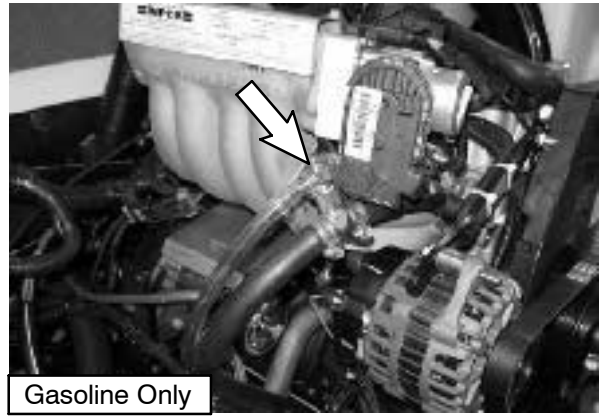

Check the radiator hoses and clamps every 200 hours of operation. Tighten the clamps if they are loose. Replace the hoses and clamps if the hoses are cracked, hardened, or swollen.

Check the radiator core exterior and hydraulic cooler fins for debris every 100 hours of operation. Blow or rinse all dust, which may have collected on the radiator, in through the grille and radiator fins, opposite the direction of normal air flow. Be careful not to bend the cooling fins when cleaning. Clean thoroughly to prevent the fins becoming encrusted with dust. Clean the radiator and cooler only after the radiator has cooled to avoid cracking.

**FOR SAFETY: When servicing machine, wear eye and ear protection when using pressurized air or water.**

Flush the radiator and the cooling system every 800 hours of operation, using a dependable cleaning compound.

## AIR FILTER INDICATOR

For machines serial number 008999 and below.

The air filter indicator shows when to replace the air filter element. Check the indicator daily. The indicator's red line will move as the air filter element fills with dirt. Do not replace the air filter element until the red line reaches 5 kPa (20 in H<sub>2</sub>O) and the "SERVICE WHEN RED" window is filled with red. The indicator's red line may return to a lower reading on the scale when the engine shuts off. The red line will return to a correct reading after the engine runs for a while.

Reset the air filter indicator by pushing the reset button on the end of the indicator after cleaning or replacing the air filter element.

For machines serial number 009000 and above.

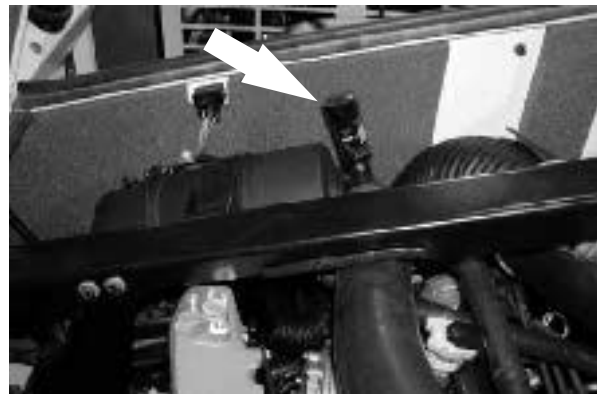
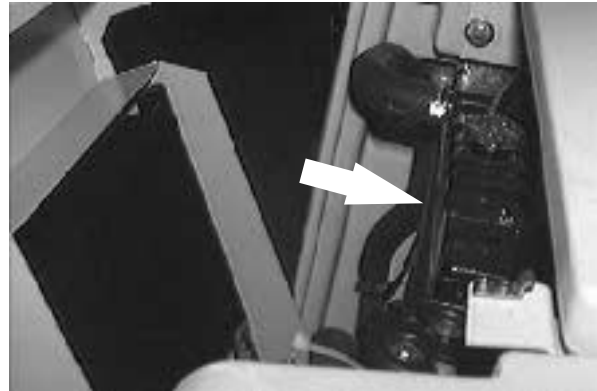

## MAINTENANCE

### AIR FILTER

For machines serial number 008999 and below.

The engine air filter housing has a dust cap and a dry cartridge-type air filter element. Empty the dust cap daily. The air filter must be replaced whenever the filter element is damaged.

Replace the air filter element every 400 hours or when the air filter indicator shows restriction in the air intake system. Do not remove the air filter element from the housing unless it is restricting air flow.



For machines serial number 009000 and above.



### SPARK PLUGS

Clean or replace, and set the gap of the spark plugs every 400 hours of operation.

The proper spark plug gap is 1 mm (0.040 in).

### CRANKCASE VENTILATION SYSTEM

Clean the crankcase ventilation hoses after every 400 hours of operation.

### TIMING BELT

Check the engine timing belt every 800 hours of operation, and replace the engine timing belt every 1600 hours of operation.

### FUEL FILTER (GASOLINE)

The fuel filter traps fuel contaminants. The filter is located on the fuel line going into the electronic fuel injection system.

Replace the filter element every 800 hours of operation.

**FOR SAFETY: When servicing machine, keep flames and sparks away from fuel system service area. Keep area well ventilated.**



**FUEL FILTER (LPG)**

The fuel filter traps fuel contaminants. The fuel filter element is located inside the fuel lockoff valve on the LPG convertor going into the electronic fuel injection system.

**FOR SAFETY: When servicing machine, keep flames and sparks away from fuel system service area. Keep area well ventilated.**

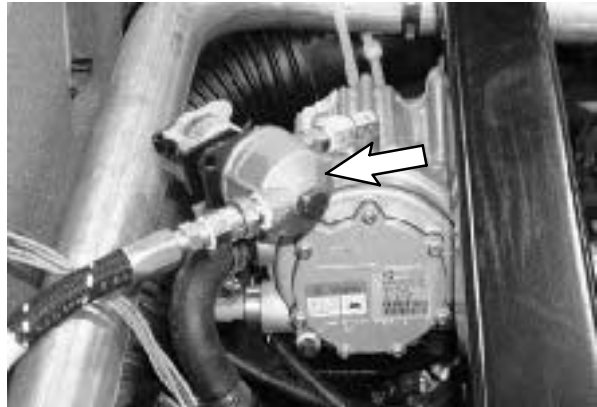

Replace the fuel filter element every 400 hours of operation.



**ELECTRONIC PRESSURE REGULATOR (LPG)  
(For machines serial number 009000 and above)**

Remove the sensor and drain the oil from the LPG electronic pressure regulator after every 100 hours of operation.

**FOR SAFETY: When servicing machine, keep flames and sparks away from fuel system service area. Keep area well ventilated.**

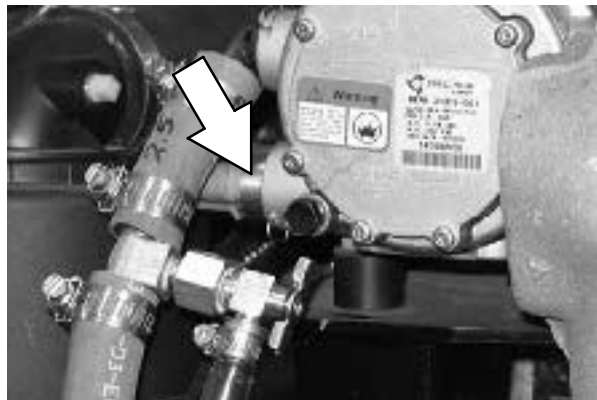

**ELECTRONIC FUEL INJECTION**

The electronic fuel injection system requires no adjustment.

The fuel injection system is equipped with a “manifold absolute pressure sensor” (MAP Sensor). The MAP sensor senses barometric pressure and automatically corrects the fuel system calibration for changes in altitude. This means the air/fuel mixture will always be optimized, regardless of elevation (or barometric pressure), however, the engine will still lose 3.5% power for every 1000 ft increase in elevation.

The Idle speed is set at 950 ± 50 rpm

# MAINTENANCE

## BATTERY

The battery for the machine is a low maintenance battery. Do not add water to the battery, or remove the battery vent plugs.

The battery is located under the operator seat.

After the first 50 hours of operation, and every 800 hours after that, clean and tighten the battery connections.

**FOR SAFETY: When servicing machine, avoid contact with battery acid.**



## PROPELLING MOTOR

Torque the shaft nut to 508 Nm (375 ft lb) lubricated, 644 Nm (475 ft lb) dry after the first 50-hours of operation, and every 800 hours there after.

## BELTS AND CHAINS

### ENGINE BELT

The engine fan belt is driven by the engine crankshaft pulley and drives the alternator pulley. Proper belt tension is 13 mm (0.50 in) from a force of 4 to 5 kg (8 to 10 lb) applied at the mid-point of the longest span.

Check and adjust the belt tension every 100 hours of operation.

 **WARNING: Moving belt and fan. Keep away.**

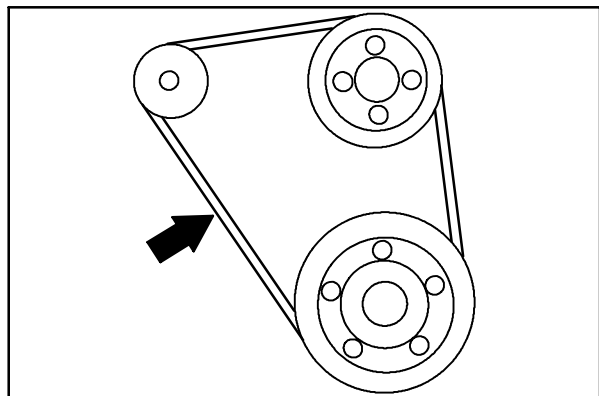

08935

### STATIC DRAG CHAIN

A static drag chain prevents the buildup of static electricity in the machine. The chain is attached to the machine frame just in front of the scrub head, on the left side of the machine.

Make sure the chain is touching the floor at all times.

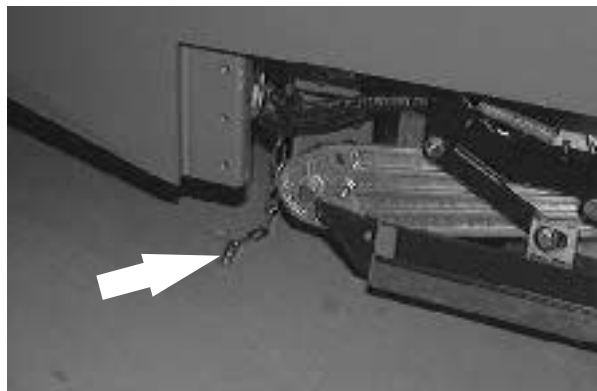



---

**SCRUB BRUSHES**

---

Two cylindrical scrub brushes span the width of the scrub head, sweeping debris into the debris tray while scrubbing the floor. The scrub brushes should be checked daily for tangled wire or string, wear, and damage.

The scrub brushes can be rotated front-to-rear, and end-for-end to increase brush life. The brushes should be replaced if large portions of the brush bristles are missing or if the remaining brush bristles measure 15 mm (0.50 in) in length.

*NOTE: Cylindrical scrub brushes must be installed with the V-patterns on the brushes pointing towards each other for best debris pick up.*

*NOTE: Be sure to replace the scrub brushes in sets. Otherwise one scrub brush will be more aggressive than the other.*

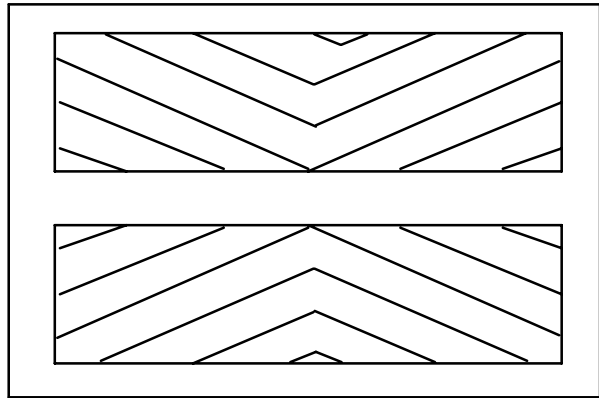

### REPLACING OR ROTATING THE SCRUB BRUSHES

1. Set the machine parking brake.
2. Turn off the solution flow switch.
3. Stop the engine.
4. Turn the ignition to accessories, do not start the engine. Lower the scrub head with the scrub switch.
5. Turn off the ignition switch.

**FOR SAFETY: Before leaving or servicing machine; stop on level surface, set parking brake, turn off machine and remove key.**

6. Open the brush door.
7. Disconnect the leveling rod from the machine frame by pulling back on the locking collar and pulling the rod end off the ball stud.



8. Remove the idler arm mounting bolt. Thread the mounting bolt into the idler arm removal hole if you are having trouble removing the idler arm.



9. Remove the brush idler plate and side squeegee assembly.

10. Pull out the front brush and then the rear brush.



11. Line up the drive end of the new or rotated brushes with the brush drive plugs. The cylindrical scrub brushes must be installed with the V-patterns on the brushes pointing towards each other. Slide the brushes onto the brush drive plugs.

*NOTE: The scrub head may need to be raise a little to insert new brushes.*

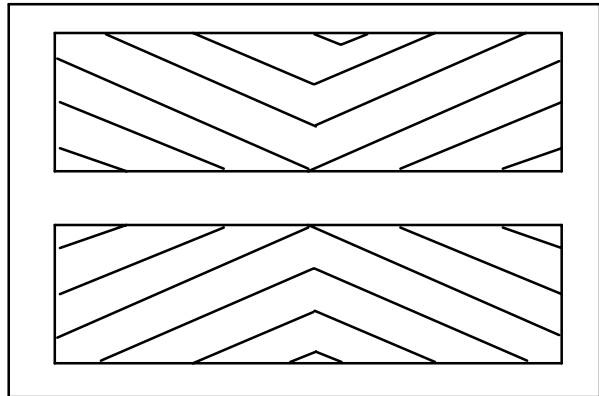

12. Insert the idler plugs into the brushes.
13. Line up the brush wrap guide pins with idler plate. Line up the idler mounting arm with the mounting pins.
14. Secure the idler mounting arm to the scrub head with the mounting bolt.
15. Pull the locking collar back on the leveling rod end and snap the leveling rod end onto the ball stud.
16. Adjust the brush pattern as described in *CHECKING AND ADJUSTING SCRUB BRUSH PATTERN.*



**CHECKING AND ADJUSTING SCRUB BRUSH PATTERN**

1. Apply chalk, or some other material that will not easily blow away, to a smooth, level floor.
2. Raise the scrub head. Position the scrub head over the chalked area.
3. Set the parking brake.

## MAINTENANCE

4. Lower the scrub head for 15 to 20 seconds while keeping the scrub head in one spot in the chalked area.

*NOTE: If chalk or other material is not available, allow the brushes to spin on the floor for two minutes. A polish mark will remain on the floor.*

5. Raise the scrub head, release the parking brake, and drive the machine away from the chalked area.
6. Observe the width of the brush pattern. If the brush patterns have parallel sides and are the same width, the brushes do not need taper adjustment.

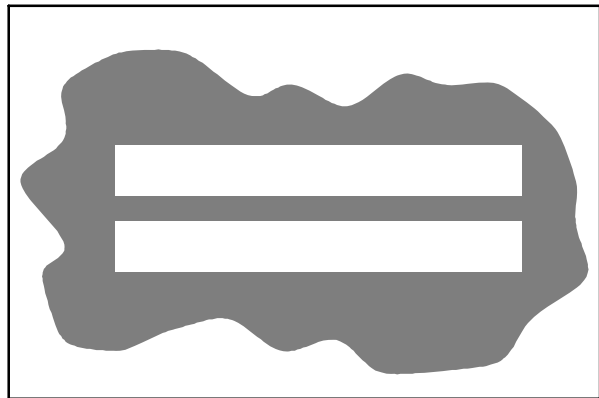

10355

If one or both of the brush patterns are tapered, the scrub head will have to be adjusted to straighten the brush pattern.

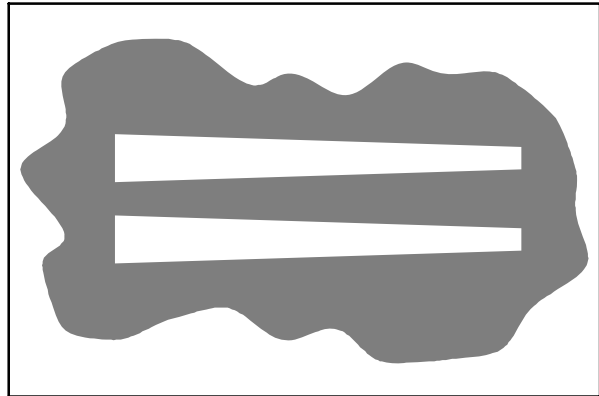

10652

- A. Loosen the three scrub head mounting bolts on the idler or drive side of the scrub head. Move the scrub head up to decrease the pattern width on that side of the scrub head. Move the scrub head down to increase the pattern width on that side of the scrub head. Tighten the mounting bolts and check the pattern again and readjust if necessary.

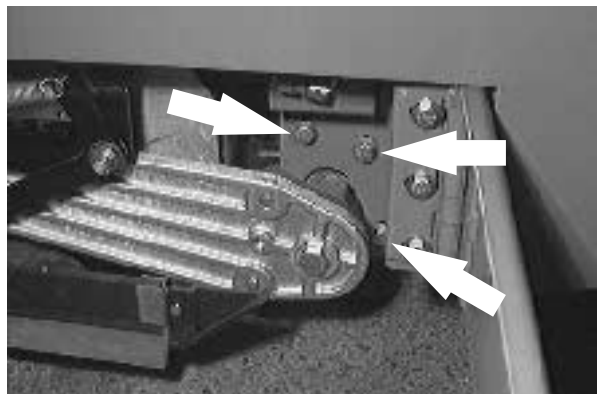

The brush patterns should be the same width. If one is narrower than the other, the scrub head needs to be leveled from front to rear.

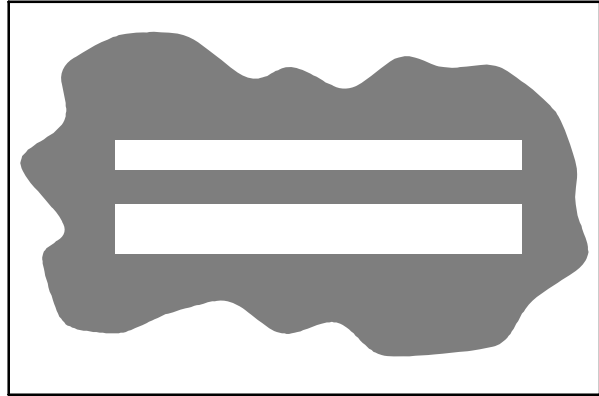

10653

- A. Lengthen or shorten the leveling rods on both sides of the scrub head. Lengthening the rods will increase the rear brush pattern width. Shortening the rods will will increase the front brush pattern.

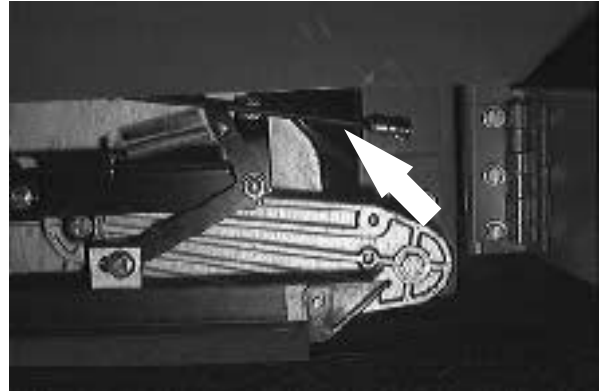

---

## SOLUTION SYSTEM

---

### RECOVERY TANK

The recovery tank stores recovered solution. The recovery tank should be drained and cleaned daily, or when the recovery tank full light comes on.

ES option: The ES filter should be cleaned daily. The ES filter can be rinsed while in the recovery tank through the right tank fill opening, or by removing the ES pump from the recovery tank.

The outside of the tank can be cleaned with vinyl cleaner.



### SOLUTION TANK

The solution tank contains the cleaning solution.

The solution tank does not require regular maintenance. If deposits form on the bottom of the tank, rinse the tank with a strong blast of warm water. The right tank can be flushed through the drain opening. Drain the tank with the solution tank drain hose.

The solution tank on machines with the ES option should be drained and cleaned daily. Rinse the solution outlet filter at the bottom of the tank through the drain access.

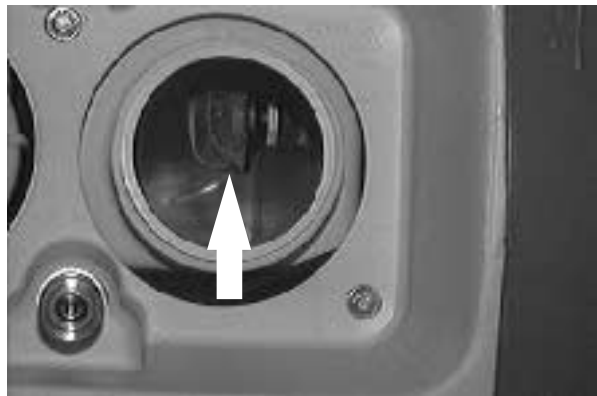

---

### DEBRIS TRAY

---

The debris tray is located between the scrub head and the squeegee. Debris from the scrub brushes is swept into the debris tray.

The debris tray can be removed from the machine. Unlatch the rear squeegee and tray assembly. Swing out the assembly. Disconnect the vacuum hose from the side of the debris tray. Slide the debris tray out, empty and clean it. Clean the debris screen located at the bottom of the tray.

Slide the debris tray into the rear squeegee and tray assembly. Connect the vacuum hose. Swing the assembly back into place and latch.



**FaST SYSTEM**

**FaST SUPPLY HOSE CONNECTOR**

The FaST supply hose connector is located on the side of the the FaST PAK holder. Soak the connector in warm water if detergent buildup is visible. When a FaST PAK carton is not installed, store the supply hose connector on the storing plug to prevent the hose from clogging.

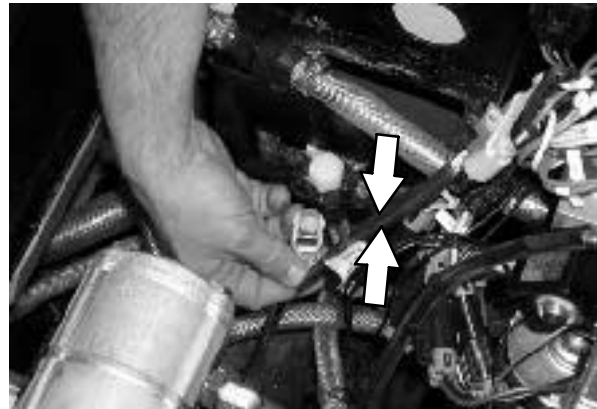

**FaST SYSTEM FILTER SCREEN**

The FaST system filter screen is located on top the scrub head and filters the water from the solution tank as it flows into the FaST system.

Remove the filter screen bowl and clean the filter screen after every 50 hours of machine operation. Empty the solution tank before removing the filter.

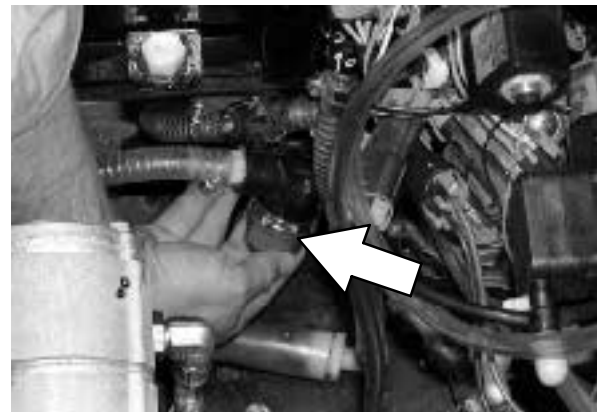

**FaST SYSTEM AIR PUMP FILTER**

The FaST system air pump filter is located on the side of the air pump.

Remove and clean out the air filter with compressed air after every 200 hours of FaST scrubbing.

**FOR SAFETY: When servicing machine, wear eye protection when using pressurized air or water.**

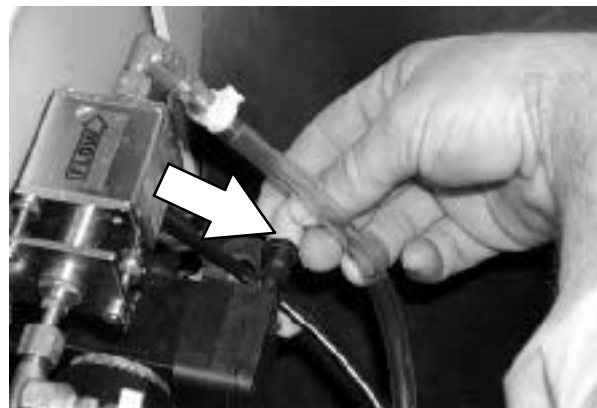

## MAINTENANCE

### FaST SPRAY TUBE

The FaST spray tube is located on the front of the scrub brush housing. Debris from the spinning scrub brushes can collect on the spray tube.

Rinse and clean the tube with a strong blast of warm water after every 50 hours of machine operation.

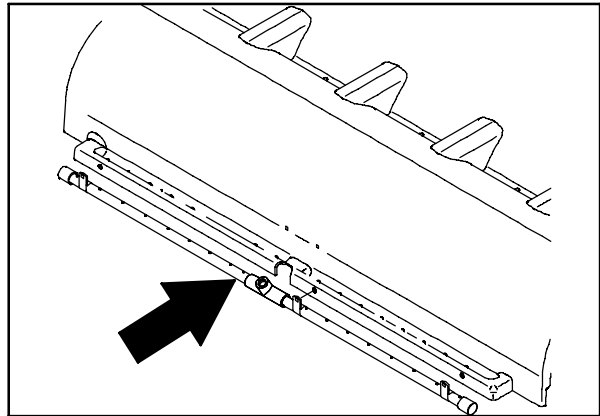

---

### SQUEEGEES

---

The squeegee channels water into the vacuum fan suction. The front blade channels the water, and the rear blade wipes the floor.

There are two types of squeegee blades available; one for smooth surfaces is standard on the machine, and one for rough surfaces is an option.

Check the squeegee blades for damage and wear daily. Rotate or replace either of the squeegee blades if the leading edge is torn or worn half-way through the thickness of the blade.

The squeegee can be adjusted for leveling and deflection. The deflection of the squeegee blades should be checked daily, or when scrubbing a different type of floor. The leveling of the squeegee should be checked every 100 hours of machine operation.

### ADJUSTING REAR SQUEEGEE BLADE DEFLECTION

Deflection is the amount of curl the squeegee blade has when the machine travels forward with the squeegee lowered to the floor. The best deflection is when the squeegee wipes the floor just dry with a minimum amount of deflection.

1. Lower the squeegee and drive the machine forward.
2. Shut off the engine and set the machine parking brake.

**FOR SAFETY: Before leaving or servicing machine; stop on level surface, set parking brake, turn off machine and remove key.**



3. Look at the deflection over the full length of the squeegee blade. The correct amount of deflection for the rear squeegee blade is 15 to 20 mm (0.50 to 0.75 in). The front slotted squeegee blade should contact the floor with a slight deflection, 5 mm (0.13 to 0.25 in).

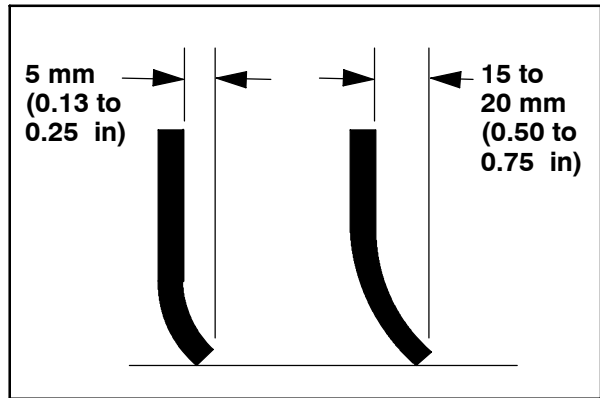

10918

4. To adjust the amount of deflection, unlock the height adjustment knobs on the two squeegee casters by sliding the locking bracket off to the side.

*NOTE: If the locking brackets won't slide over, lift up the end of the squeegee to pick the caster up off the floor slightly. Then slide the locking bracket over.*

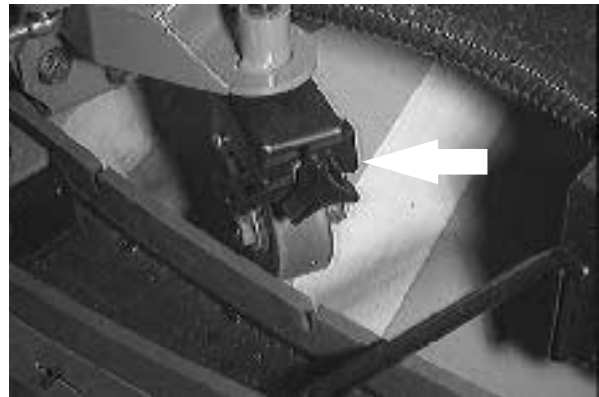

5. Turn the adjustment knob clockwise to decrease deflection, turn the adjustment knob counter-clockwise to increase the deflection. Be sure to turn the knobs the **same** number of turns.
6. Start the engine and drive the machine forward again to check the squeegee blade deflection. Readjust the squeegee blade deflection if necessary.
7. Slide the locking brackets back to lock the height adjustment knobs.
8. Raise the squeegee when finished.

### LEVELING THE REAR SQUEEGEE

Leveling of the squeegee assures even contact over the length of the squeegee blade with the surface being scrubbed. Make sure this adjustment is done on an even, level floor.

1. Lower the squeegee and drive the machine forward.
2. Shut off the engine and set the machine parking brake.

**FOR SAFETY: Before leaving or servicing machine; stop on level surface, set parking brake, turn off machine and remove key.**

3. Look at the deflection over the full length of the squeegee blade.
4. If the deflection is not the same over the full length of the blade, loosen the locking nut on the two rear squeegee balljoints.

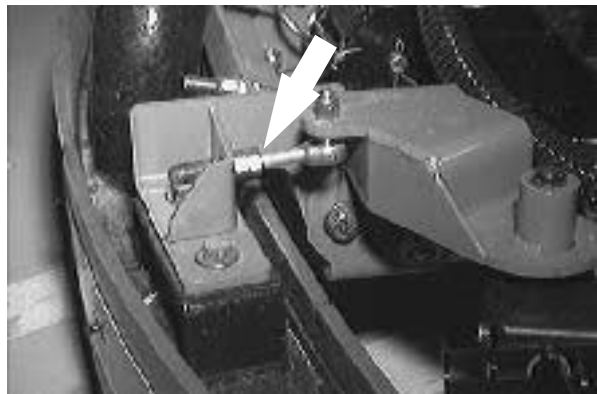

5. Turn the balljoint adjustment nut clockwise, from the rear of the machine, to increase the deflection at the ends of the squeegee. Turn the balljoint adjustment nut counter-clockwise, from the rear of the machine, to decrease the deflection at the ends of the squeegee blade.

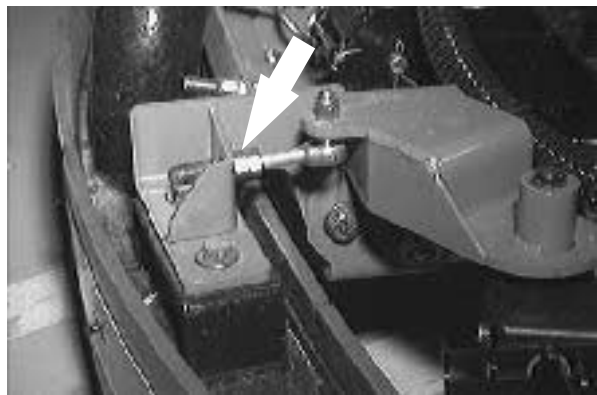

6. Tighten the locking nuts.
7. Start the engine and drive the machine forward again to check the squeegee blade deflection.
8. Readjust the squeegee blade deflection if necessary.

---

## SQUEEGEE BLADES

---

### REAR SQUEEGEE

Check the squeegee blades for damage and wear daily. Rotate or replace either of the squeegee blades if the leading edge is torn or worn half-way through the thickness of the blade.

The rear squeegee has two squeegee blades. Each blade has four wiping edges. To use them all, start with one wiping edge. To use the next wiping edge, rotate the blade end-for-end. To use the next wiping edge, rotate the top edges down, bottom edges up. To use the last edge, rotate the blade end-for-end.

Replace any worn or damaged squeegee blades.

### REPLACING OR ROTATING REAR SQUEEGEE BLADES

1. Make sure the squeegee is raised off the floor.
2. Shut the engine off and set the parking brake.

**FOR SAFETY: Before leaving or servicing machine; stop on level surface, set parking brake, turn off machine and remove key.**

3. Open the retaining band clamp and remove the squeegee blade.

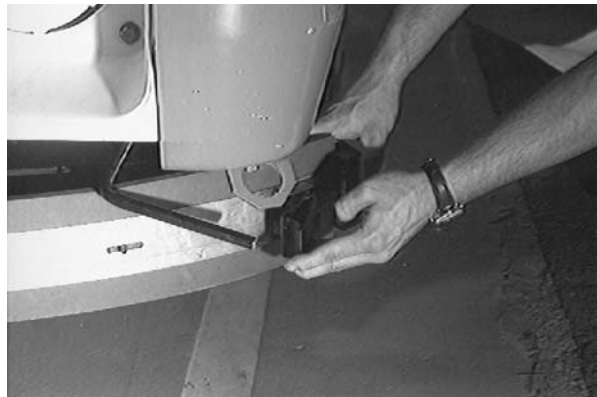

## MAINTENANCE

4. Replace or rotate the squeegee blade to allow a new edge to face the front of the machine.
5. Place the squeegee blade over the pins of the squeegee frame.
6. Position the retaining band over the squeegee blade. Latch the retaining band clamp.
7. Adjust the squeegee blade leveling and deflection as stated in *LEVELING THE REAR SQUEEGEE* and *ADJUSTING REAR SQUEEGEE BLADE DEFLECTION*.

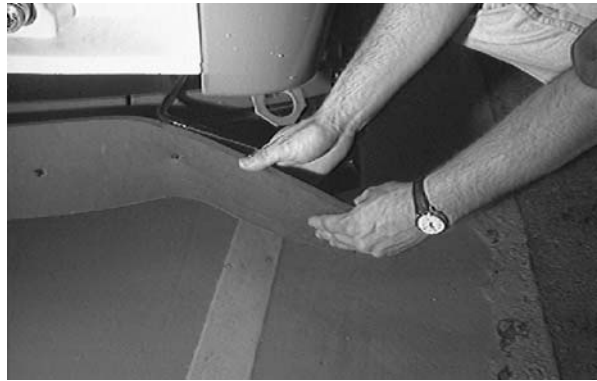

### SIDE SQUEEGEES

The side squeegees control water spray and channel water into the path of the rear squeegee. Check the side squeegees for damage and wear daily. Replace the side squeegee blades whenever they become damaged or lose their shape or resilience. Replace the squeegee deflectors whenever they become worn.

#### REPLACING SIDE SQUEEGEE BLADES

1. Raise the scrub head.
2. Shut off the engine and set the machine parking brake.

**FOR SAFETY: Before leaving or servicing machine; stop on level surface, set parking brake, turn off machine and remove key.**

3. Remove the cotter pin, clevis pin, deflector, and the retainer bracket from the front of the side squeegee.
4. Pull the squeegee blade out the front of the squeegee frame.
5. Slide the new squeegee blade onto the frame.

*NOTE: Lubricating the squeegee frame where the squeegee makes contact will make it easier to install the squeegee blade.*

6. Replace the retainer bracket, deflector, clevis pin, and cotter pin.
7. Repeat for the side squeegee on the other side of the scrub head.

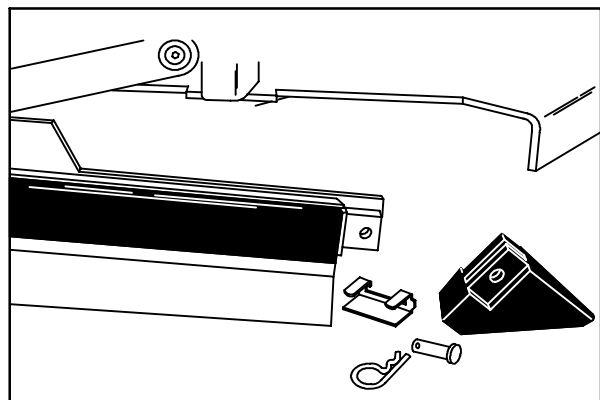

059420

---

**SKIRTS AND SEALS**

---

**SCRUB HEAD SKIRTS**

A skirt is mounted on each side of the scrub head. Check the skirts for wear or damage every 100 hours of operation.

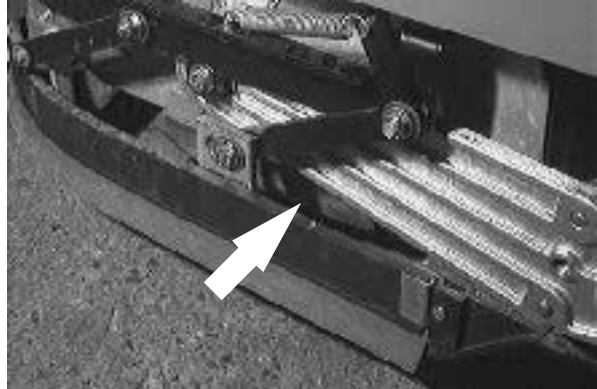
**COVER SEALS**

Check the solution and recovery tank cover seals for wear or damage every 100 hours of operation



## BRAKES AND TIRES

### SERVICE BRAKES

The mechanical service brakes are located on the rear wheels. The brakes are operated by the foot brake pedal and connecting cables.

Check the brake adjustment every 200 hours of operation.

### PARKING BRAKE

The parking brake is set with the parking brake pedal that activates the service brakes.

Check the parking brake adjustment every 200 hours of operation.

### TIRES

The machine tires are solid. Check the tires every 100 hours of operation for damage.

### FRONT WHEEL

Torque the front wheel nuts twice in the pattern shown to 122 to 149 Nm (90 to 110 ft lb) after the first 50-hours of operation, and every 800 hours there after.

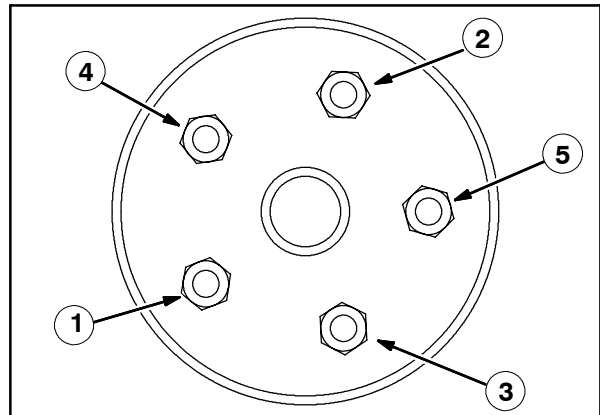

**PUSHING, TOWING, AND TRANSPORTING THE MACHINE**

**PUSHING OR TOWING THE MACHINE**

If the machine becomes disabled, it can be pushed from the front or rear, but towed only from the rear.

The propelling pump has a bypass valve to prevent damage to the hydraulic system when the machine is being pushed or towed. This valve allows a disabled machine to be moved for a *very short distance* and at a speed to not exceed 1.6 kp/h (1 mph). The machine is NOT intended to be pushed or towed a long distance or at a high speed.

**ATTENTION! Do not push or tow machine for a long distance and without using the bypass valve, or the machine hydraulic system may be damaged.**

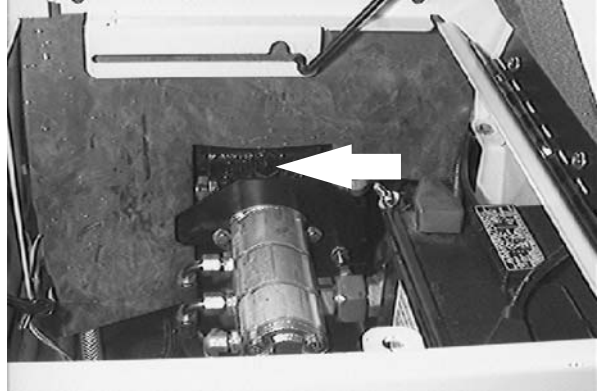

Turn the bypass valve 90° from the normal position before pushing or towing the machine. **The illustration shows the bypass valve in the pushing or towing position.**

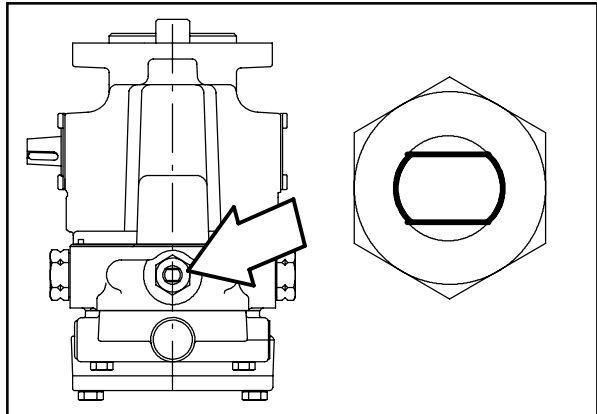

## TRANSPORTING THE MACHINE

1. Position the rear of the machine at the loading edge of the truck or trailer.
2. If the loading surface is not horizontal or is higher than 380 mm (15 in) from the ground, use a winch to load machine.

If the loading surface is horizontal AND is 380 mm (15 in) or less from the ground, the machine may be driven onto the truck or trailer.

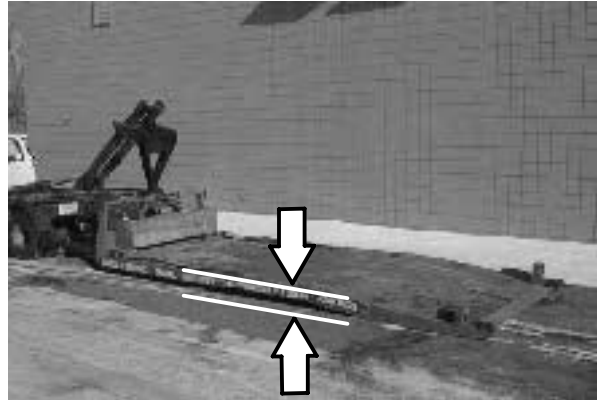

3. To winch the machine onto the truck or trailer, attach the winching chains in the holes at the bottom of the rear bumper.



If the machine has the optional rear tie down brackets, attach the winching chains to them.

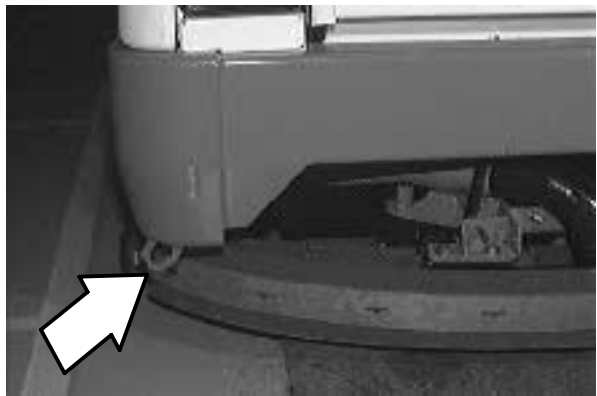

4. Turn the bypass valve 90° from the normal position before winching the machine onto the truck or trailer. See *PUSHING OR TOWING THE MACHINE* section of this manual. Make sure the machine is centered.

**FOR SAFETY: When loading machine onto truck or trailer, use winch. Do not drive the machine onto the truck or trailer unless the loading surface is horizontal AND is 380 mm (15 in) or less from the ground.**

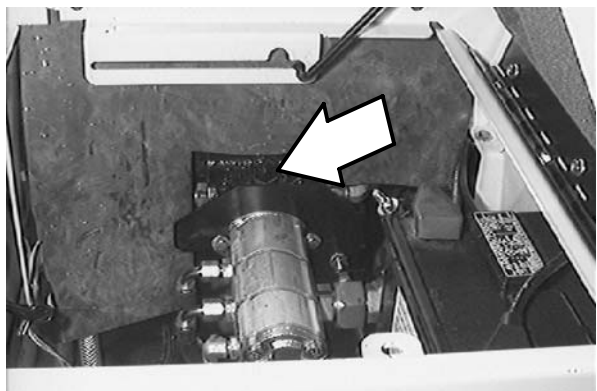



5. Position the machine onto the truck or trailer as far as possible. If the machine starts to veer off the centerline of the truck or trailer, stop and turn the steering wheel to center the machine.
6. Set the parking brake and block the machine tires. Tie down the machine to the truck or trailer before transporting.

The front tie down locations are in the holes at the bottom of the front bumper. If the machine has the optional tie down brackets, use them to tie down the machine.

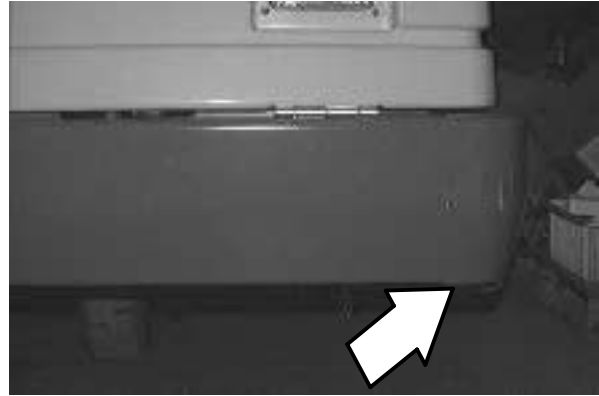

The rear tie down locations are in the holes at the bottom of the rear bumper. If the machine has the optional rear tie down brackets, use them to tie down the machine.



7. If the loading surface is not horizontal or is higher than 380 mm (15 in) from the ground, use a winch to unload machine.

If the loading surface is horizontal AND is 380 mm (15 in) or less from the ground, the machine may be driven off the truck or trailer.

**FOR SAFETY: When unloading machine off truck or trailer, use winch. Do not drive the machine off the truck or trailer unless the loading surface is horizontal AND 380 mm (15 in) or less from the ground.**

### MACHINE JACKING

---

Empty the recovery and the solution tanks before jacking the machine. You can jack up the machine for service at the designated locations. Use a hoist or jack that will support the weight of the machine. Always stop the machine on a flat, level surface and block the tires before jacking the machine up.

**FOR SAFETY: Before leaving or servicing machine; stop on level surface, set parking brake, turn off machine and remove key.**

The front jacking location is the left front corner of the machine frame.



The rear jacking locations are the two rear corners of the machine frame.

**FOR SAFETY: When servicing machine, block machine tires before jacking machine up.**

**FOR SAFETY: When servicing machine, jack machine up at designated locations only. Block machine up with jack stands.**



---

### STORING MACHINE

---

Before storing the machine for an extended period of time, the machine needs to be prepped to lessen the chance of rust, sludge, and other undesirable deposits from forming. Contact your Tennant service personnel.

---

## OPTIONS

---

### SIDE BRUSH

The side brush has a disk scrub brush, a squeegee blade, and a skirt. Check the squeegee blade and brush daily for damage and wear.

#### REPLACING THE SIDE SCRUB BRUSH

1. Raise the side brush.
2. Shut off the engine and set the parking brake.

**FOR SAFETY: Before leaving or servicing machine; stop on level surface, set parking brake, turn off machine and remove key.**

3. Press the brush spring clip ends together with your thumb and index finger. The brush will drop off the drive hub
4. Line up the new side brush drive socket with the drive hub.
5. Lift and snap the side brush onto the drive hub.
6. Check to make sure the brush is securely mounted on the drive hub.

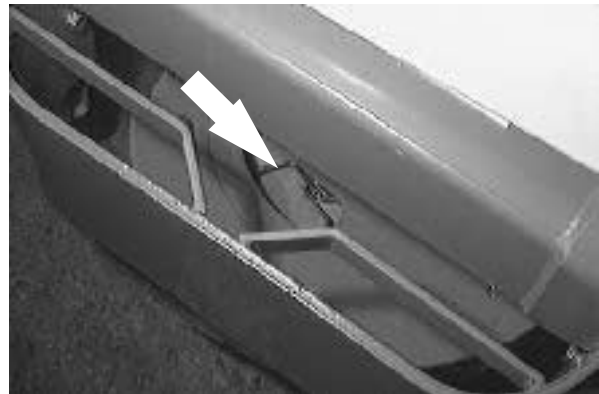

## MAINTENANCE

### REPLACING THE SQUEEGEE BLADE

1. Raise the side brush.
2. Shut off the engine and set the parking brake.

**FOR SAFETY: Before leaving or servicing machine; stop on level surface, set parking brake, turn off machine and remove key.**

3. Remove the side brush guard.
4. Remove the retainer clip from the end of the squeegee.
5. Pull the squeegee blade out the front of the squeegee frame.
6. Slide the new squeegee blade onto the frame.

*NOTE: Lubricating the squeegee frame where the squeegee makes contact will make it easier to install the squeegee blade.*

7. Install the retainer clip on the end of the squeegee.
8. Install the side brush guard.



### SIDE BRUSH SKIRT

The side brush skirt is located behind the squeegee blade. Check the skirt for wear and damage every 100 hours of operation.



**SPECIFICATIONS**

**GENERAL MACHINE DIMENSIONS/CAPACITIES**

Item	Dimension/capacity
Length	2460 mm (97 in)
Width	1525 mm (60 in)
Width with optional side brush	1600 mm (63.0 in)
Height	1475 mm (58 in)
Height with overhead guard	2045 mm (80.5 in)
Main scrub brush diameter	280 mm (11 in)
Main scrub brush length	1145 mm (45 in)
Side scrub brush diameter (option)	405 mm (16 in)
Squeegee width	1525 mm (60 in)
Scrubbing path width	1145 mm (45 in)
Scrubbing path width with optional side brush	1450 mm (57 in)
Debris tray volume capacity	42 L (1.5 ft <sup>3</sup> )
Solution tank	265 L (70 gal)
Recovery tank	273 L (72 gal)
Detergent tank (option)	25 L (6.7 gal)
Total capacity with ES (option)	398 L (105 gal)
GVWR	2087 kg (4600 lb)

**GENERAL MACHINE PERFORMANCE**

Item	Measure
Maximum forward speed	12.9 kmh (8 mph)
Maximum reverse speed	6.4 kmh (4 mph)
Minimum aisle turn width	3185 mm (125.5 in)
Minimum turning radius, right	2660 mm (104.75 in)
Minimum turning radius, left	2030 mm (79.75 in)
Maximum rated incline for scrubbing	6°
Maximum rated incline for transport of machine	8°

**FaST SYSTEM**

Item	Measure
Solution pump	12 Volt DC, 11A, 11.6 LPM (3.0 GPM) open flow, 45 psi bypass setting
Low solution flow rate	2.7 LPM (0.7 GPM)
High solution flow rate	5.4 LPM (1.4 GPM)
Detergent pump	12 Volt DC
Low concentrate flow rate	2.6 CC/Minute (0.085 Liquid Ounces/Minute)
High concentrate flow rate	5.2 CC/Minute (0.17 Liquid Ounces/Minute)
Air pump	12 Volt DC, 0.6 Maximum Amp draw
Air pump flow rate	8.7 LPM (0.3 CFM) open flow

# SPECIFICATIONS

## POWER TYPE

Engine	Type	Ignition	Cycle	Aspiration	Cylinders	Bore	Stroke
GM 1.6	Piston	Distributorless-type spark	4	Natural	4	79 mm (3.11 in)	81.5 mm (3.21 in)
	Displacement		Net power, governed		Net power, maximum		
	1600 cc (98 cu in)		27.75 kw (37 hp) @ 2400 rpm		41.25 kw (55 hp) @ 4000 rpm		
	Fuel		Cooling system		Electrical system		
	Gasoline, 87 octane minimum, unleaded. Fuel tank: 42 L (11.2 gal)		Water/ethylene glycol antifreeze		12 V nominal		
	LPG, Fuel tank: 15 kg (33 lb)		Total: 7.5 L (2 gal) Radiator: 3.8 L (1 gal)		75 A alternator		
	Idle speed, no load		(Fast) governed speed, under load		Firing order		
	950 ± 50 rpm		2400 ± 50 rpm		1-3-4-2		
	Spark plug gap		Valve clearance, cold		Engine lubricating oil with filter		
	1 mm (0.04 in)		No Adjustment OHC Engine		3.5 L (3.7 qt) 5W/30 SAE-SG/SH		

## STEERING

Type	Power source	Emergency steering
Front wheel, hydraulic cylinder and rotary valve controlled	Hydraulic accessory pump	Manual

## HYDRAULIC SYSTEM

System	Capacity	Fluid Type
Hydraulic reservoir	38 L (10 gal)	TENNANT part no. 65869 - above 7° C (45° F)
Hydraulic total	74 L (19.5 gal)	TENNANT part no. 65870 - below 7° C (45° F)

## BRAKING SYSTEM

Type	Operation
Service brakes	Mechanical drum brakes (2), one per rear wheel, cable actuated
Parking brake	Utilize service brakes, cable actuated

## TIRES

Location	Type	Size	Pressure
Front (1)	Solid	460 x 130 mm (5 x 18 in)	-
Rear (2)	Solid	460 x 130 mm (5 x 18 in)	-

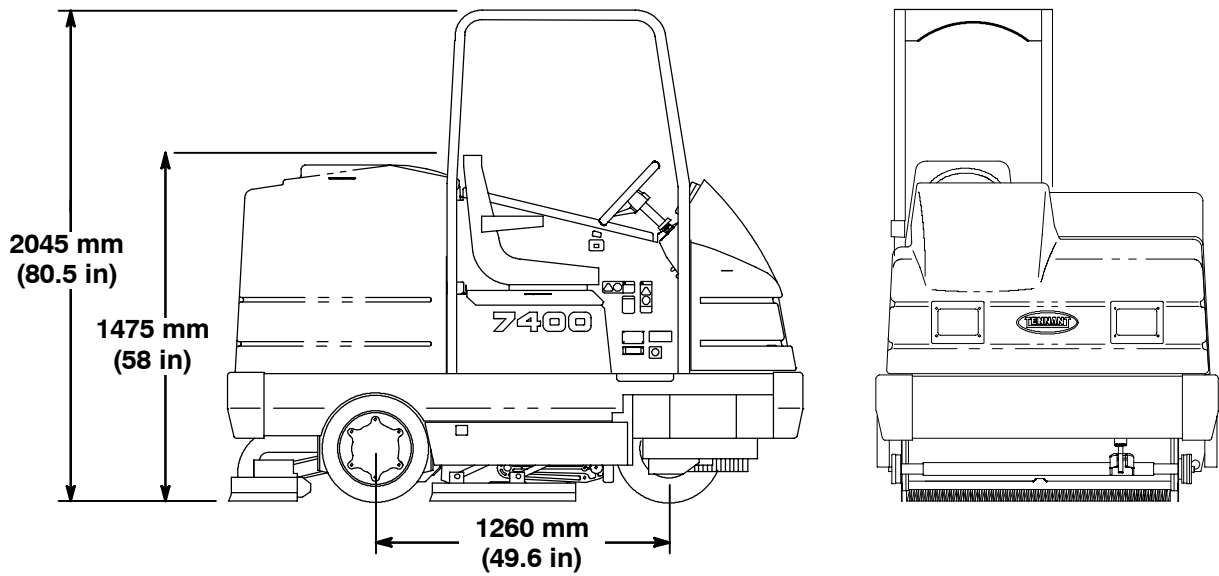
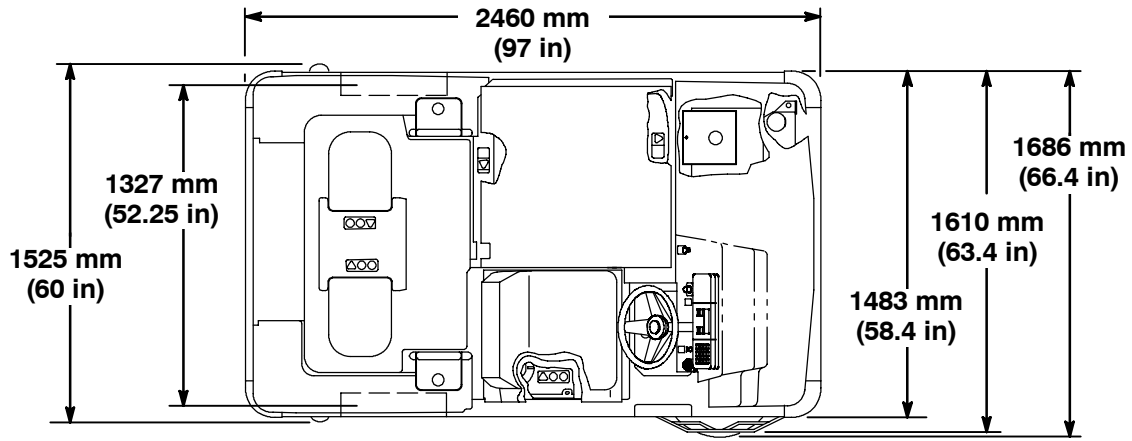

**MACHINE DIMENSIONS**

10919

**A**

Adjusting rear squeegee blade deflection, 70  
Air filter, 60  
  Dust cap, 60  
  Element, 60  
Air filter indicator, 59  
Aisle turn, 83

**B**

Battery, 62  
  Charging system, Light, 12  
Belts, 62  
  Engine fan belt, 62  
Brake pedal, 12  
Brakes, 27, 76  
  Parking, Adjustment, 76  
  Service, 76  
  System specifications, 84  
Brushes, 33  
  Door latch, 24  
  Scrub brush switch, 17  
  Scrub brushes, 33  
Button, Horn, 19  
Bypass valve, 77

**C**

Capacities, 83  
Chains, 62  
  Static drag, 62  
Changing LPG fuel tank, 30  
Charging system light, 12  
Check engine light, 20  
Circuit breakers, 20  
Control panel  
  Detergent flow switch, 16  
  Engine oil pressure, 12, 13  
  Engine speed switch, 18  
  ES switch, 16  
  Fuel level gauge, 15  
  Fuel level low light, 14  
  High engine temperature light, 13  
  Hourmeter, 14  
  Maintenance mode light, 13  
  OK light, 14  
  Recovery tank full light, 14  
  Scrub brush switch, 17  
  Side brush, 16  
  Squeegee switch, 15

Controls, 10  
  Brake pedal, 12  
  Charging system light, 12  
  Check engine light, 20  
  Circuit breakers, 20  
  Cover release knob, 18  
  Detergent flow switch, 16  
  Directional pedal, 11  
  Engine oil pressure light, 13  
  Engine speed switch, 18  
  ES switch, 16  
  FaST solution flow switch (option), 22  
  FaST switch (option), 22  
  Fuel level gauge, 15  
  Fuel level low light, 14  
  Fuses, 21  
  High engine temperature light, 13  
  Horn Button, 19  
  Hourmeter, 14  
  Ignition switch, 19  
  Latches, 24  
  Maintenance mode, 13  
  OK light, 14  
  Operation, 11–24  
  Parking brake pedal, 12  
  Recovery tank full light, 14  
  Scrub brush switch, 17  
  Side brush, 16  
  Solution flow switch, 22  
  Squeegee switch, 15  
  Steering column tilt handles, 19  
  Steering wheel, 18  
Cover release knob, 18  
Covers  
  Engine, Latch, 24  
  Seals, 75  
  Solution tank, Latch, 24  
Crankcase ventilation system, 60

**D**

Debris Tray, 68–71  
Debris tray  
  Latch, 24  
  Remove and clean, 45  
Detergent flow switch, 16  
Dimensions, 83  
Directional pedal, 11  
Doors  
  Brush, Latch, 24  
  Engine side, Latch, 24  
Double scrubbing, 39  
Draining and cleaning tanks, 40–42



**E**

Electrical  
 Battery, 62  
 Circuit breakers, 20  
 Ignition switch, 19

Electrical system, Fuses, 21

Electronic fuel injection, 61

Electronic Pressure Regulator, 61

Engine, 57–59  
 Air filter, 60  
 Air filter indicator, 27, 59  
 Coolant temperature, Light, 13  
 Cooling system, 57  
 Cover latch, 24  
 Crankcase ventilation system, 60  
 Electronic fuel injection, 61  
 Electronic Pressure Regulator, 61  
 Fan belt, 62  
 Fuel filters (Gasoline), 60  
 Fuel filters (LPG), 61  
 Lubrication, 54  
 Oil capacity, 54  
 Oil level, 27  
 Oil pressure, Light, 13  
 Side door latch, 24  
 Spark Plugs, 60  
 Specifications, 84  
 Speed switch, 18  
 Timing belt, 60

Engine oil pressure light, 13

Engine speed switch, 18

ES filter, 68

ES switch, 16

**F**

FaST, System, 69

FaST pak agent, Installing, 28–30

FaST pak agent installation, 28–30

FaST solution flow switch, 22

FaST Spray Tube, 70

FaST Supply Hose Connector, 69

FaST switch, 22

FaST System, 69  
 FaST supply hose connector, 69

FaST system, 26

FaST System Air Pump Filter, 69

FaST System Filter Screen, 69

Filling the tanks, 34

**Filter**

FaST System Air Pump Filter, 69  
 FaST System Filter Screen, 69

**Front wheel**

Lubrication, 54  
 Propelling motor shaft torque, 62  
 Wheel nuts torque, 76

Fuel, Check for leaks, 45

Fuel filters, 60, 61

Fuel level, 27

Fuel level gauge, 15

Fuel level low light, 14

Fuel tank, Changing LPG, 30

Fuses, 21

**G**

Gauge, Fuel level, 15

Grease fittings, Front wheel support, 54

Grille, Latch, 24

**H**

Handles, Steering column tilt, 19

High engine temperature light, 13

Horn button, 19

**Hoses**

Recovery tank drain, 23  
 Solution tank drain, 23

Hourmeter, 14

How the machine works, 25

Hydraulic fluid, 56

Hydraulic fluid reservoir, 55

Hydraulic hoses, 56

**Hydraulics, 55**

Fluid, 56–58  
 Fluid filter, 55  
 Fluid level, 55  
 Hoses, 56  
 Propelling motor, 62  
 Reservoir, 55  
 System specifications, 84

**I**

Ignition switch, 19

Incline, Rated, 45

**J**

Jack points, 80–82

**K**

Knobs, Cover release, 18

**L**

Latches, 24

Debris tray, 24

Engine cover, 24

Engine side door, 24

Grille, 24

Scrub brush doors, 24

Solution tank cover, 24

Leveling the rear squeegee, 72

Lights

Charging system, 12

Check engine, 20

Engine oil pressure, 13

Fuel level low, 14

High engine temperature, 13

Maintenance mode, 13

OK, 14

Recovery tank full light, 14

LPG

Changing the fuel tank, 30

Service valve, 45

Lubrication, 54

Engine, 54

Front wheel support, 54

Rear wheel bearings, 54

Scrub brush idler, 55

**M**

Machine components, 8

Machine dimensions, 85

Machine jacking, 80–82

Machine leaks, 45

Machine tie down location, 79

Maintenance, 52–73

Intervals, 52

Recommended, 7

Maintenance chart, 52

Maintenance mode light, 13

Motors, Propelling, 62

**O**

OK, Light, 14

OK light, 14

Operation, 7–52

Operation on inclines, 45

Operator Responsibility, 7

Operator seat, 24

Options, 46–48, 81

Detergent flow switch, 16

ES switch, 16

Replacing side brush, 81

Replacing side brush squeegee blade, 82

Side brush, 81

Side brush skirt, 82

Side brush switch, 16

Vacuum wand, 46–48

**P**

Parking brake, 76

Parking brake pedal, 12

Pedals

Brake, 12

Directional, 11

Parking brake, 12

Post-operation checklist, 45

Pre-operation checklist, 27

Pushing machine, 77

Pushing or towing the machine, 77

Pushing, towing, and transporting machine, 77

**R**

Radiator, 59

Coolant level, 57

Coolant type, 57

Flushing system, 59

Hoses, 59

Rated incline, 45

Rear squeegee, 73–75

Blade deflection, 70

Leveling, 72

Replacing blades, 73–75

Rear wheel bearings, 54

Recovery tank, 68

Drain and clean, 45

Drain hose, 23

Full light, 14

Recovery tank drain hose, 23

Recovery tank full light, 14  
 Replacing rear squeegee blades, 73–75  
 Replacing side brush, 81  
 Replacing side brush squeegee blade, 82  
 Replacing side squeegee blades, 74

## S

### Safety

Labels, 5–7  
 Precautions, 3–5

Screen, FaST System Filter Screen, 69

Scrub brush idler, Lubrication, 55

Scrub brush switch, 17

Scrub brushes, 33, 63–66

Check, 45  
 Checking brush pattern, 65  
 Door latch, 24  
 Information, 33  
 Replacing, 64–66  
 Switch, 17

Scrub head skirt, 75

Scrubbing, 36

Double, 39

Scrubbing and brush information, 33

Seals, 75–79

Covers, 75

Seat, 24

Adjustment, 24  
 Lift, 24

Service records, 45

Side brush, 81

Replacing brush, 81  
 Replacing squeegee blade, 82  
 Skirt, 82  
 Switch, 16

Side brush switch, 16

Side squeegees, 74

Replacing blades, 74

Skirts, 75–77

Scrub head, 75

Solution, Tank drain hose, 23

Solution flow switch, 22

Solution outlet filter, 68

Solution system, 68

Detergent flow switch, 16  
 ES switch, 16  
 Flow switch, 22

Recovery tank, 68

Solution tank, 68

Solution tank, 68

Cover latch, 24

Drain and clean, 45

Drain hose, 23

Outlet filter, 68

Solution tank drain hose, 23

Spark plugs, 60

Specifications, 83–85

Braking system, 84

FaST System, 83

Hydraulic system, 84

Machine capacities, 83

Machine dimensions, 83

Machine performance, 83

Power type, 84

Steering, 84

Tires, 84

Squeegee switch, 15

Squeegees, 70–72

Blade deflection, 70

Blades, 73

Deflection, 27, 45

Leveling, 72

Rear, 73–75

Replacing rear blades, 73–75

Replacing side blades, 74

Side, 74

Switch, 15

Starting the machine, 31

Static drag chain, 62

Steering, 27

Specifications, 84

Steering column tilt handle, 19

Steering wheel, 18

Stop scrubbing, 39

Stop the machine, 43

Storing machine, 80

Switches

Detergent flow, 16

Engine speed, 18

ES, 16

FaST, 22

FaST solution flow, 22

Ignition, 19

Scrub brush, 17

Side brush, 16

Solution flow, 22

Squeegee, 15

Symbol definitions, 9

## T

Tie down location, 79

Timing belt, 60

Tires, 76

    Specifications, 84

Towing machine, 77

Transporting machine, 77

Transporting the machine, 78

Travel speed, 83

Tray, Debris, 68–71

Troubleshooting, 49–51

## V

Vacuum fan, Switch, 15

Vacuum hoses, Check, 45

Vacuum wand, 46–48